

MUTARS[®]



implantcast

**Modular Universal Tumor And
Revision System**

25 Years MUTARS® - 2017



- 2018 The 50,000th MUTARS® implantation will be performed
- 2016 Market launch of the EPORE® metaphyseal components
- 2015 Market launch of the EPORE® cones
- 2014 The first 3D-printed, CE certified prosthesis - EPORE® - gets implanted
- 2013 Market launch MUTARS® GenuX® MK
- 2010 The MUTARS® RS Arthrodesis gets implanted for the first time
- 2009 First implantation of a LUMiC® prosthesis
- 2007 CE certification for MUTARS® silver
- 2005 Performance of the first MUTARS® Xpand surgery
- 2004 The first MUTARS® silver implantation takes place
- 2002 First implantation of the MUTARS® proximal humerus
- 2000 Performance of the 1000th MUTARS® implantation
- 1998 The MUTARS® revision system gets implanted for the first time
- 1995 Introduction of the first MUTARS® proximal tibia on the market
- 1993 Performance of the first MUTARS® distal femur surgery
- 1992 The first MUTARS® implantation is performed

MUTARS®

Modular Universal Tumor And Revision System

MUTARS® was developed in co-operation
with Univ.-Prof. Dr. W. Winkelmann (ex-director) and
Univ.-Prof. Dr. G. Gosheger (director) Department of General Orthopaedics
and Orthopaedic Oncology at the University Hospital of Münster, Germany.
MUTARS® is in successful clinical use since 1992.

Table of Contents

Introduction	2
Information about components with PEEK-lock	4
Silver coating	6
TiN-coating	7
Special customized implants and instruments C-Fit 3D®	8
EPORE® defect filler	9
System Overview A-E	10
A Femoral Implants	
A.1 Proximal Femoral Replacement	14
A.1.1 Proximal Femoral Replacement Revision	15
A.2 Distal Femoral Replacement MK	16
A.3 Distal Femoral Replacement MK with RS Stem	16
A.4 Total Femoral Replacement MK	17
A.5 Proximal Femoral Replacement with intramedullary connected GenuX® MK	17
B Tibial Implants	
B.1 Total Knee Replacement MK with Distal Femur or with KRI	18
B.2 Proximal Tibia MK Replacement	18
C Other	
C.1 Arthrodesis Implant	19
C.2 Diaphyseal Implant	19
C.3 Attachement tube	29
D. Humeral Implants	
D.1 Proximal Humeral Replacement and Humerus Inverse	20
D.2 Distal Humeral Replacement	21
D.3 Total Humeral Replacement	21
D.4 Proximal Ulna Replacement	22
D.5 Total Elbow Replacement	22
D.6 Humeral Diaphyseal Implant	22
E. Revision Implants	
E.1 MUTARS® RS Hip System	23
E.2 MUTARS® RS Arthrodesis	23
E.3 GenuX® MK Knee Revision System	24
E.3.1 GenuX® MK Knee Revision System Monoblock	24
E.4 Intramedullary Total Femoral Replacement with GenuX® MK	26
E.5 KRI MK - Knee Reconstruction Implant	26
E.6 Intramedullary Total Femoral Replacement with KRI MK	27
E.8 LUMIC®	27
MUTARS® Biopsy Punch	28
Flexible Drill Nitinol	28
MUTARS® Xpand and BioXpand	30
MUTARS® Implants	32
MUTARS® Instruments	39



Introduction

The treatment of a major osseous defect in orthopaedic oncology focuses heavily on surgical techniques that are intended to preserve the affected limb as much as possible. Hence amputation, rotationplasty and arthrodesis is avoided as much as each patient's status will allow. The main options therefore involve the use of allograft and/or autologous graft and/or tumour prosthesis. And, in recent years modular segmental replacement systems have become increasingly popular as they offer the the surgeon a way to treat patients with defects which can vary significantly in size on an individual basis and with confidence.

Since it's introduction in 1992 the MUTARS® (**M**odular **U**niversal **T**umour **A**nd **R**evision **S**ystem) has been successfully used for the treatment of major osseous defects of the lower and upper extremities. Its modular design was developed in co-operation with Univ.-Prof. Dr. W. Winkelmann* (em. Director) and Univ.-Prof. Dr. G. Gosheger (Director), Department of General Orthopaedics and Orthopaedic Oncology at the University Hospital of Münster, Germany. The system shows good functional results and allows an individualised solution for major osseous defects, including arthroplasties of the adjacent joints.

In the 25 years since its introduction more than 45,000 successful MUTARS® implantations have been performed. Our co-operation with leading European clinics has enhanced the continuous development of the implants and instruments, resulting in the proven versatile offerings available today. This close collaboration enables us to always remain up-to-date and continue further development by using the latest experience in the Tumour prosthesis sector by modifying our products according to current clinical best practice techniques and knowledge.

Perhaps the best example of this has been the development of the GenuX® MK (Modular Knee) in 2013 which built on the clinical success of the GenuX® knee revision implant which has been in use since 2006. The GenuX® MK has been developed to offer the intraoperative choice between Mobile-Bearing and Fixed-Bearing PE inserts. Specifically, the focus of this recent development was on the design of new tibial and femoral components to minimise bone resection as well as on the production of more intuitive instrumentation. The biomechanically optimized MUTARS® GenuX® MK coupling allows for 130° flexion.

To simplify the system the same stems are intended for use both on the femur and the tibia in conjunction with offset adapters. The tibial and femoral components of the GenuX® MK system are fully compatible in tumour treatments with all MUTARS® standard products. With the MK components, the Mobile-Bearing option is possible. MUTARS® MK combines the advantages of the GenuX® MK system and the established MUTARS® system.

In tumour and revision surgery alike, it is very often not clear preoperatively just how much viable bone will actually be available intraperatively. Moreover, this problem or uncertainty can be made even worse after any in-situ implants have been removed. It is highly important therefore to be able to adapt intraoperatively with a highly modular and quality system in all situations. With four sizes of femoral component, four sizes of tibial component, cemented stems and cementless stems (in four lengths and nine diameters) as well as four offset tibial and femoral stem adapters (each having 360° of rotational freedom) available the MUTARS® MK system offers the surgeon the intraoperative flexibility required. Additionally each of the four sizes of (left-sided or right-sided) femoral component may be combined with size-specific 5mm and/or 10mm thick posterior and/or distal augments to help fill any bony defects. Similarly each of the four sizes of tibial component may be combined with size-specific spacers - unicondylar options are available in 5mm and/or 10mm and/or 15mm and/or 20mm thicknesses while bicondylar options are available in 25mm or 35mm or 45mm thicknesses. The patella can be replaced by a cemented PE implant. Because the surgeon has the opportunity to combine a total of 152 components it is possible to create the optimal treatment for each individual case.

In summary the MUTARS® MK system combines intuitive instruments with a functional range of well designed implants to flexibly address the vast majority of clinical scenarios. The surgical technique is simple enough that the MUTARS® MK system can be effectively mastered after a relatively short learning curve.

Standard augmentation can only go so far so the EPORE® defect fillers, or cones, were made available in early 2017. They were developed to provide additional augmentation in knee reconstruction and are effective in reinforcing and rebuilding the implant fixation surfaces in scenarios of more extensive bone loss. The tibial options come in a range of sizes each with multiple configurations as do the femoral options which are also sided to make installation easier. They are made from titanium alloy ($TiAl_6V_4$) and the outer implant surface of EPORE® features a porous structure which supports bone ingrowth. Please refer to page 9 for more Information.

The non-invasive MUTARS® Xpand Growing Prosthesis has been developed together with our partner company Wittenstein Intense. The first implantations of the biological Growing Prosthesis MUTARS® BioXpand have shown promising results. Up until 2017 a total of 650 MUTARS® Xpand and MUTARS® BioXpand Growing Prostheses have been implanted successfully. More detailed information about it can be found on page 30 and 31 of this brochure.

For some years now the CE certified MUTARS® Silver components have been considered standard option for the treatment of tumour patients in several major tumour centers throughout Europe and to date more than 12,500 successful MUTARS® Silver implantations have been performed. More information can be found on page 6.

The modular MUTARS® system provides the surgeon with the ability to offer patients a functional joint replacement in cases of major osseous defects whether they be caused by tumour resection, fracture or by the removal of an infected (or non-infected) prosthesis. Joint replacements in the upper limb may be carried out using the constrained hinge joint at the elbow, the anatomic shoulder components or indeed the inverse shoulder options available. In the lower limb the constrained rotational components are available for the knee while at the hip a combination of regular components with the MUTARS® system allows for hemi arthroplasty or the total joint replacement. Depending on the type of prosthesis used and the clinical scenarios encountered fixation can be achieved with or without cement.



Fig. 1: Hexagonal implant bed in a bone model



Fig. 2: Adjustment of the version angle

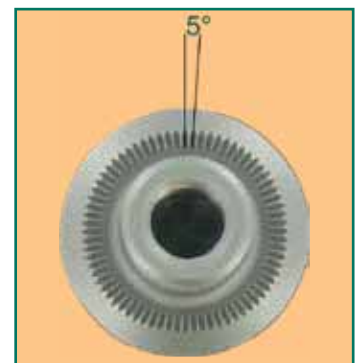

Fig. 3: MUTARS® tothing

There are two types of intramedullary stems available: one designed for a cementless fixation ($TiAl_6V_4$) and one designed for cementation (CoCrMo). The cementless stem has a microporous surface and is also available with a hydroxylapatite coating (HA).

The stems have a hexagonal cross section (Fig. 1) which provide for an optimal intramedullary fixation. In the femoral area, the stem was designed to correspond with the physiological antecurvature of the femur. Hexagonal rasps are used to achieve a primary stability of 70 Nm [1]. For an alternative method of cementless fixation there are special tapered stems and the RS stems and the RS coupling device available to meet specific bone geometries and clinical conditions.

The toothed connecting faces of all components allow precise intraoperative adjustment of the rotational angle relative to the pre-implanted implanted stem. Thus, rotational malalignments can be avoided or corrected. The teeth also allow an exact intraoperative adjustment in 5° increments of the version angle in the lower extremities or 10° in the upper extremities (Fig. 2 shows an example in the hip and Fig. 3 shows the MUTARS® tothing).

[1] Orthopädie und Orthopädische Chirurgie, C. J. Wirth und L. Zichner, 2005 Georg Thieme Verlag AG



Introduction

In order to provide the correct implant length in each individual case The MUTARS® system consists of a range of extension pieces to allow an intra-operative adjustment in 20mm increments (10mm increments for the total femoral replacement). On special request a 30mm extension piece is available to adjust the implant length for the lower extremity in increments of 10mm. The localisation and size of the tumour determines the name of the MUTARS® treatment.

Soft tissue refixation or capsular reconstruction is performed using the MUTARS® Attachment tube (made of PET polyethylene terephthalate), which is fixed to the prosthesis by means of a non-absorbable suture material, which can reduce the probability of luxation of the shoulder and hip joint.

As an additional prevention against allergic reactions, most components that are made of CoCrMo alloy may optionally be finished with a titanium nitride coating (TiN). If individual cases require special component features, the modular MUTARS® system can be supplemented by custom manufactured components, which have a 4 week delivery time-frame, thus providing an optimal solution for each individual case. Up until the end of 2016 a total of 3025 custom devices have been implanted globally.

Information about treatments with PEEK-lock and M-O-M-coupling

The brochure contents all knee treatments with the latest MK coupling. The suffix „MK“ clearly defines these types of knee treatments. I.e. in chapter A.2 the Distal Femoral Replacement MK is described. Please use the nomenclature when placing an order to prevent misunderstandings or mistakes. All knee treatments using the PEEK-lock and the former M-O-M-coupling are still available. Please refer to the known MUTARS® brochure (see below on the left) to order these components.

Additional information about the special customized implants and instruments can be found on page 8 as well as in the the C-Fit 3D® case study brochure in two volumes (depicted to the right below along with their reference numbers for ordering purposes). Similarly more on the Xpand growing prostheses can be found on page 30 of this document and in a specific brochure (depicted below in the centre along with its reference number for ordering purposes).

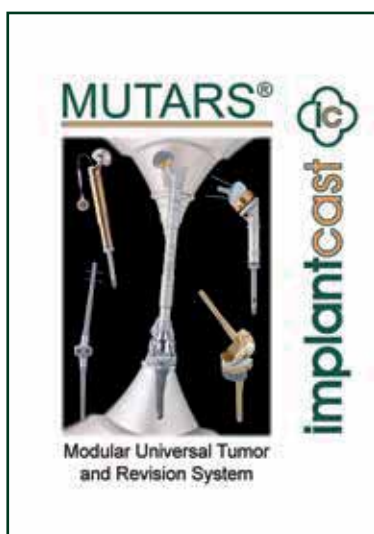

Order No/REF No: MUTSYOVE



Order No/REF No: MUGROWPE



Order No/REF No:
Vol. 1: CFITCASE
Vol. 2: CFITCA2E



**MK components for
MUTARS® MK femoral treatments**

**MK components for
MUTARS® MK tibial treatments**

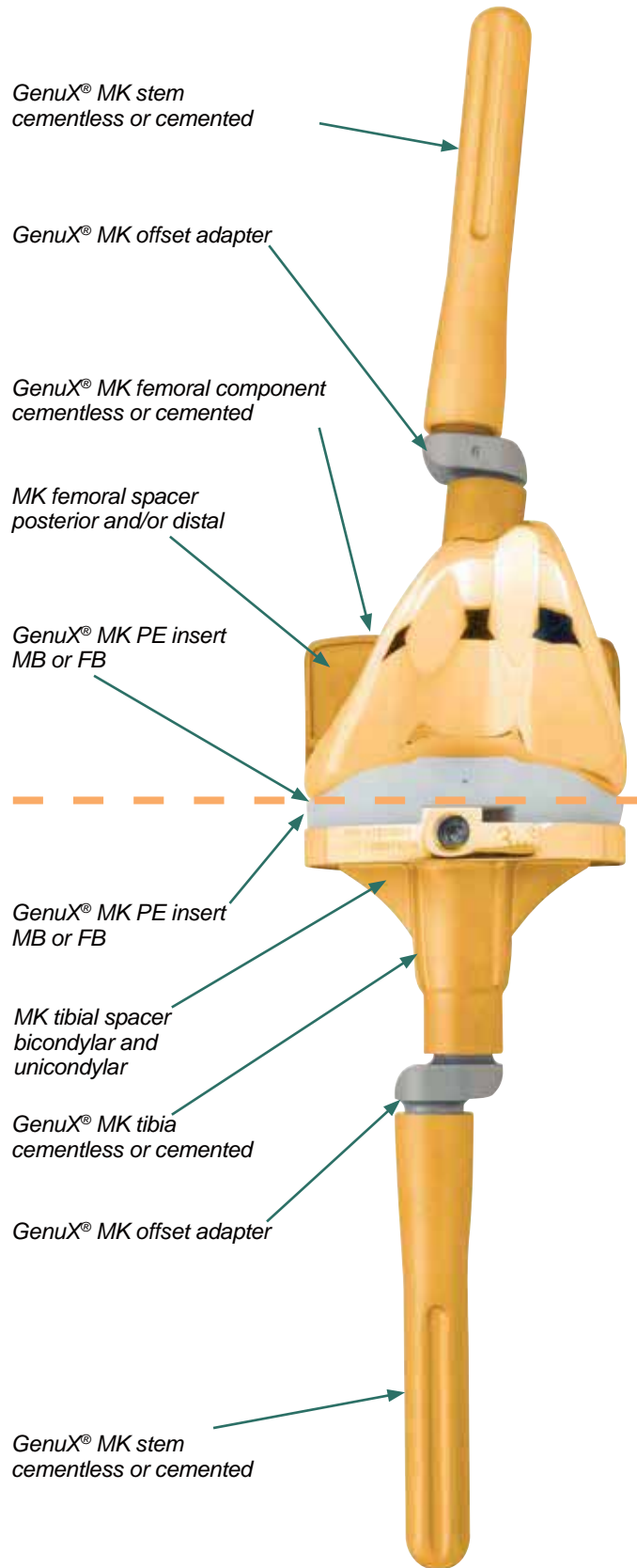



Fig. 3: Total Humerus Inverse



Fig. 4: Distal Femur M-O-M *SN coated with *Silver* and TiN



Fig. 5: Distal Femur M-O-M, with *Silver* coated plates on the PE plugs

The Silver coating

Infections represent the most severe complications of tumour arthroplastic treatments. Although local and systemic antibiotic treatments are considered, the scientific literature reports of infection rates from 5 to 35 percent [1]. Reasons for these high rates are, for example, the long surgery time, the large incisions and the immunosuppression due to chemotherapy and radiotherapy as well as the increasing resistance of the bacteria against antibiotic drugs.

Silver, in particular free silver ions, is well known for its broad-spectrum antimicrobial activity. The silver coating has been shown to reduce bacterial colonization on the device surface.

Until now only non-articulating surfaces and surfaces without direct bony contact are coated with silver.

In the catalogue information of this surgical technique you can find the supplement *S indicating which MUTARS® components are available in a silver coated version. The eight digit REF number receives an addition after the last digit (e.g. 5220-0020S). Items which are available with Silver and TiN coating have the suffix SN after the last digit (e.g. 5720-0005SN).

Important intra-operative instructions for the use of silver-coated implants

It is not permitted to flush the wound with antiseptics that contain H₂O₂, Iodine or heavy metals (such as Betaisodona®) and acetic acid during surgery since this can lead to a subsequent loss of effectiveness of the silver coating due to their oxidative properties. Alternatively, solutions such as NaCl or Lavasept® and Prontosan® can be used. The additional use of antibiotic-containing bone cement can be an advantage particular in case of a septic revision.

[1] Gosheger et al. 2004. Silver-coated megaendoprostheses in a rabbit model – an analysis of the infection rate and toxicological side effects. *Biomaterials* 25, 5547-5556.



Fig. 6: GenuX®, TiN coated

chromium ion release test [4]

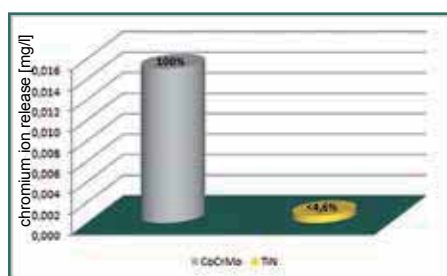
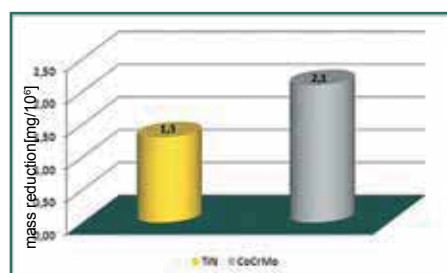
wear test acc. to
DIN ISO 14243 [5]Fig. 7: The properties of the
TiN-coatingFig. 8: Distal Femur,
TiN coated

The TiN coating for allergy prophylaxis

All metallic implant components release ions to their environment over time. In some patients such ions can elicit allergic reactions. Nickel, cobalt and chromium, which are elements of the base material CoCrMo of the articulating implant components, are considered the most frequently allergy eliciting metals [2]. The TiN-coating is biocompatible and acts like a barrier; the potential release of allergy eliciting ions of the base material is reduced to a minimum [3]. Also in clinical practice there have never been any evidence of allergic reactions with implants that have been TiN-coated showing an intact surface [5]. Therefore the TiN-coating on implant components is especially suitable for patients with sensitivity to nickel, chromium or cobalt [4][5].

Since almost all components of the MUTARS® tumor system consist of titanium alloy, this only concerns those components, which are made of a CoCrMo alloy. The REF-numbers of the TiN-coated implants have the suffix N after the last digit (e.g. 5720-0005N). Items which are available with Silver and TiN coating have the suffix SN after the last digit (e.g. 5720-0005SN).

[2] Eben R et al. (2009) Implantatallergieregister - ein erster Erfahrungsbericht. Orthopäde 38: 557-562

[3] Wisbey et al. (1987) Application of PVD TiN coating to Co-Cr-Mo based surgical implants. Biomaterials, 11

[4] Prof. Thomas LMU München Final Report Effect of a TiNbN or TiN surface coating on cobaltchromium- molybdenum and stainless steel test specimens regarding the release of nickel, chromium and cobalt: evaluation via eluate analysis and in-vitro cytokine release from peripheral human blood cells, Data on file

[5] Baumann A. (2001) Keramische Beschichtungen in der KTEP Standardlösung für Allergiker. JATROS Orthopädie & Rheumatologie 6: 16-17

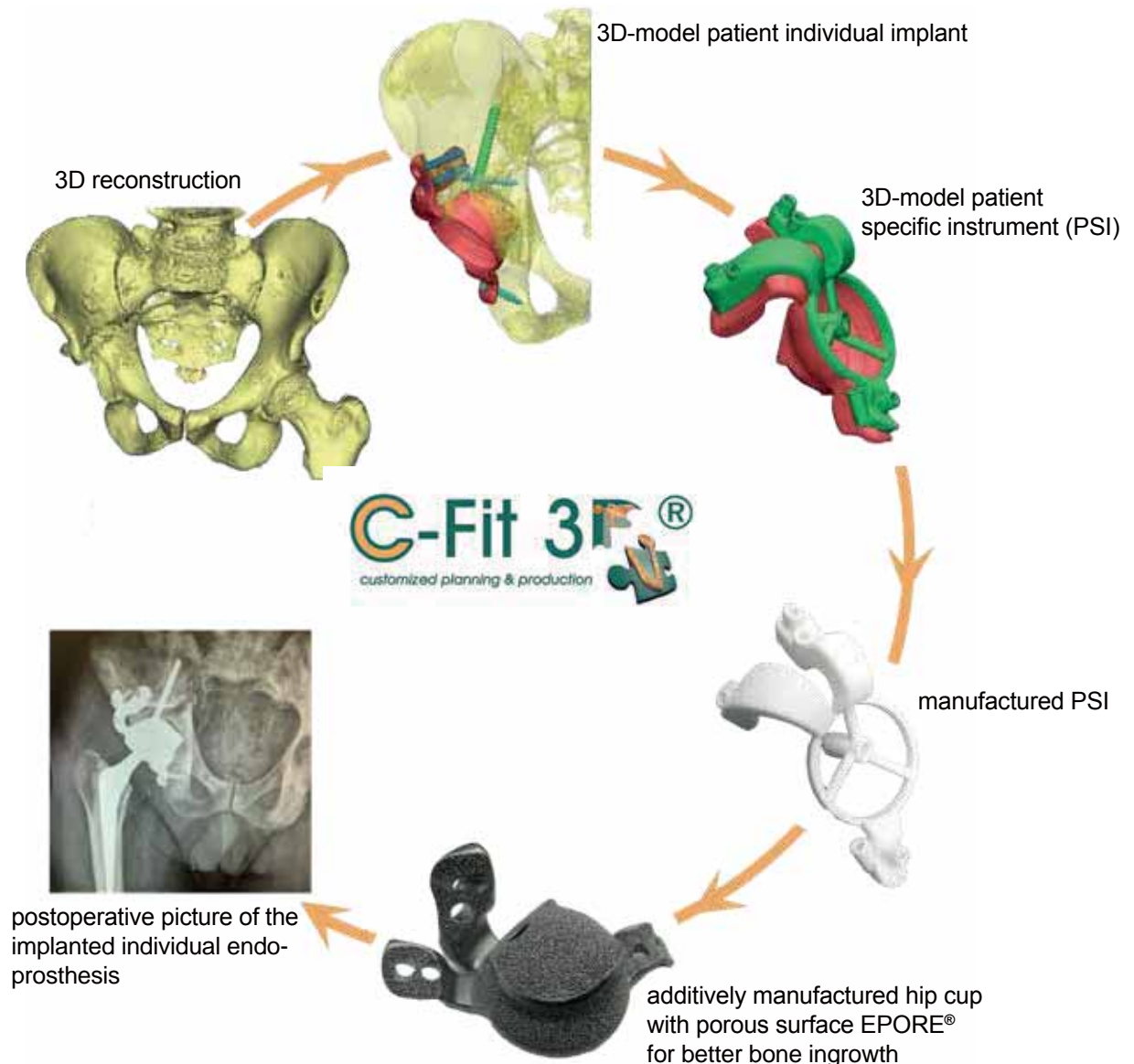

3D planning and manufacturing of individual endoprosthesis - C-Fit 3D®

Some complicated and/or extensive bony defects (perhaps created after implant removal or tumour resection) cannot be treated adequately by standard prostheses alone and therefore a custom prosthesis is sometimes required. The implantcast custom service has been available for some years and has recently been improved by the provision of additive 3D printing technology and investment in the associated software. It is now possible for us to create a 3D model of the deficient bone and/or joint from high-resolution MRI or CT data which can then be used to create the patient-specific prosthesis and any required instrumentation with the help of clinician input. Our highly experienced bio engineers work closely with the clinician to plan and produce a solution based on clinician specifications and patient requirements. This method enables exact adjustment of the implant to the anatomical conditions of the patient and the precise planning leads to minimized bone loss. Due to its highly accurate planning capability the risk of infection is also minimized resulting from the shortened operation time. The additive manufacturing enables our implants to be designed with the highly porous EPORE® surface giving a structure with a low modulus of elasticity that also enhances biological in-growth. The structure is characterized by rods of 330-390 µm thickness which are arranged in such a way that it mimics cancellous bone. The production time for such an individual prosthesis, depending on its complexity, is approximately 2-9 weeks.

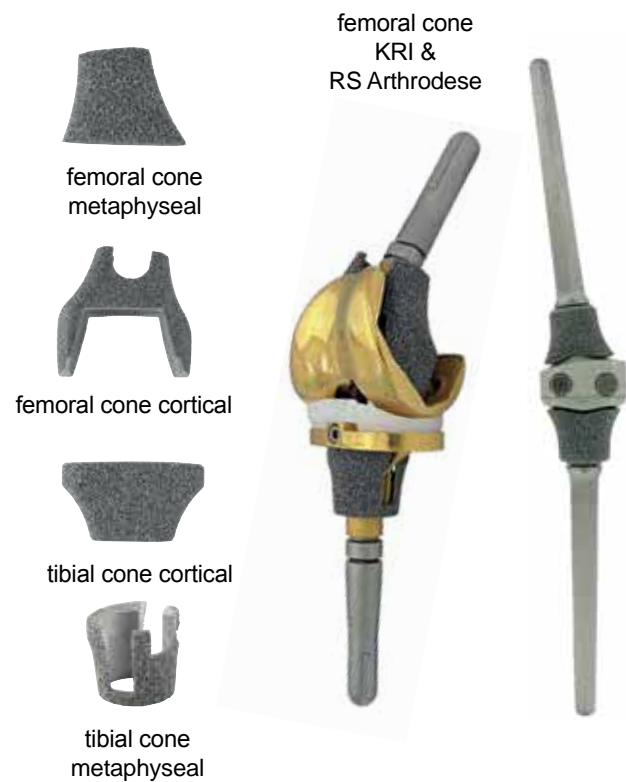
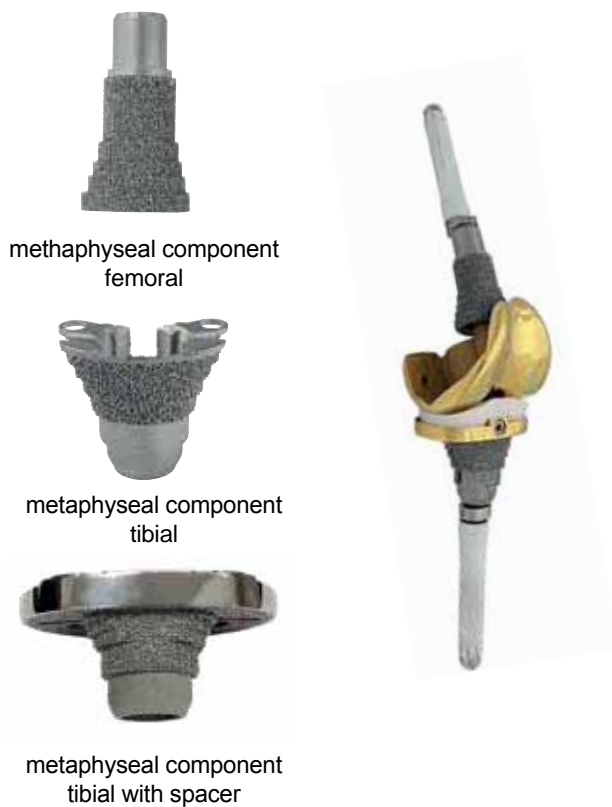

EPORE® defect fillers

Standard augmentation can only go so far hence the (TiAl₆V₄) EPORE® defect fillers, or cones were developed to provide additional augmentation in knee reconstruction and are effective in reinforcing and rebuilding the implant fixation surfaces in scenarios of more extensive bone loss. A range of sizes and configurations is available (see below) each featuring an outer implant surface which is porous in structure so that it supports bone ingrowth.

EPORE® metaphyseal components

EPORE® metaphyseal components are used to fill smaller central bone defects in the metaphysis and are usually placed in cancellous bone.

The tibial EPORE® component is screwed directly to the tibial tray just like a standard augment but the femoral EPORE® component is connected by a morse taper to the femoral implant to form a strong coupling.

The outer surfaces of EPORE® metaphyseal components are porous and are hence intended for cementless fixation directly against bone. Due to the direct fixation of the EPORE® metaphyseal components with the knee endoprosthesis, the implantation is performed cementlessly.

The EPORE® metaphyseal components are available for the implant systems
MUTARS® GenuX® MK
and ACS® SC MB.

For further information refer to the EPORE® defect filler brochure. REF EPCMFLYE

EPORE® cones

EPORE® cones are designed for addressing larger defects and are usually anchored against cortical bone. The EPORE® metaphyseal cones for the MUTARS® KRI and MUTARS® RS Arthrodesis are designed to fit their special geometry.

When implanting an EPORE® cone it is first impacted securely without cement into the metaphyseal bone until it is stable and correctly aligned. Then the chosen knee prosthesis is cemented in place. The EPORE® cones and the cones for KRI and RS arthrodesis can thus be used in combination with competitor products.





A Femoral Implants

- | | |
|--|---|
| A.1 Proximal Femoral Replacement | Replacement of the proximal femur |
| A. 1.1 Proximal Femoral Replacement Revision | Replacement of the prox. femur with retention of greater trochanter |
| A.2 Distal Femoral Replacement MK | Replacement of the distal femur with knee joint |
| A.3 Distal Femoral Replacement MK | Replacement of the distal femur with RS stem |
| A.4 Total Femoral Replacement MK | Replacement of the entire femur with knee joint |
| A.5 Prox. Femoral Replacement with MK | Replacement of the prox. femur with IM. conn. to the knee |

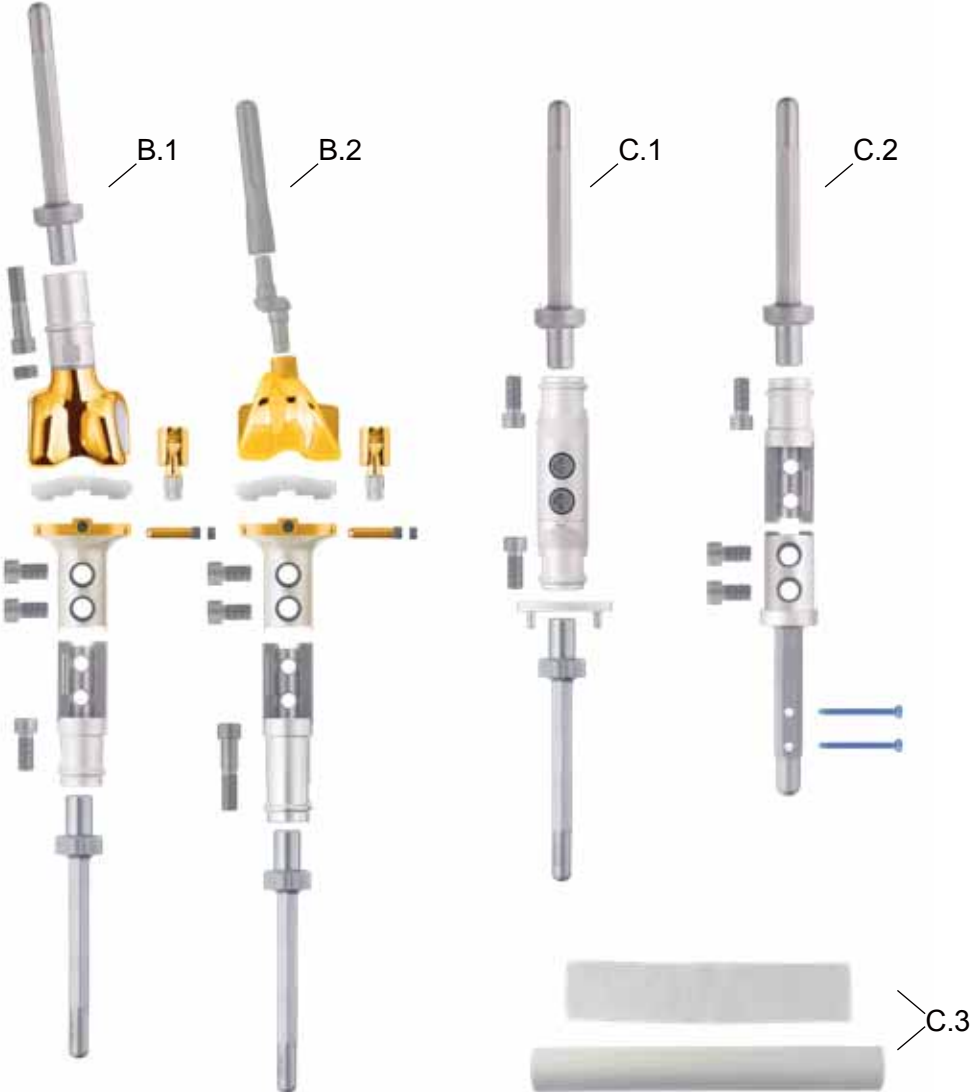

B Tibial Implants / C Other

- B.1 Total Knee Repl. MK
- B.2 Proximal Tibial MK
- C.1 Arthrodesis Implant
- C.2 Diaphyseal Implant
- C.3 Attachment tube

Knee arthroplasty with Proximal Tibia and Distal Femur or KRI
Replacement of the proximal tibia with resurfacing of the femur
Fusion of the knee joint
Diaphyseal reconstruction of femoral or tibial defect
Soft tissue reattachment at the tibia, femur and humerus



System Overview D

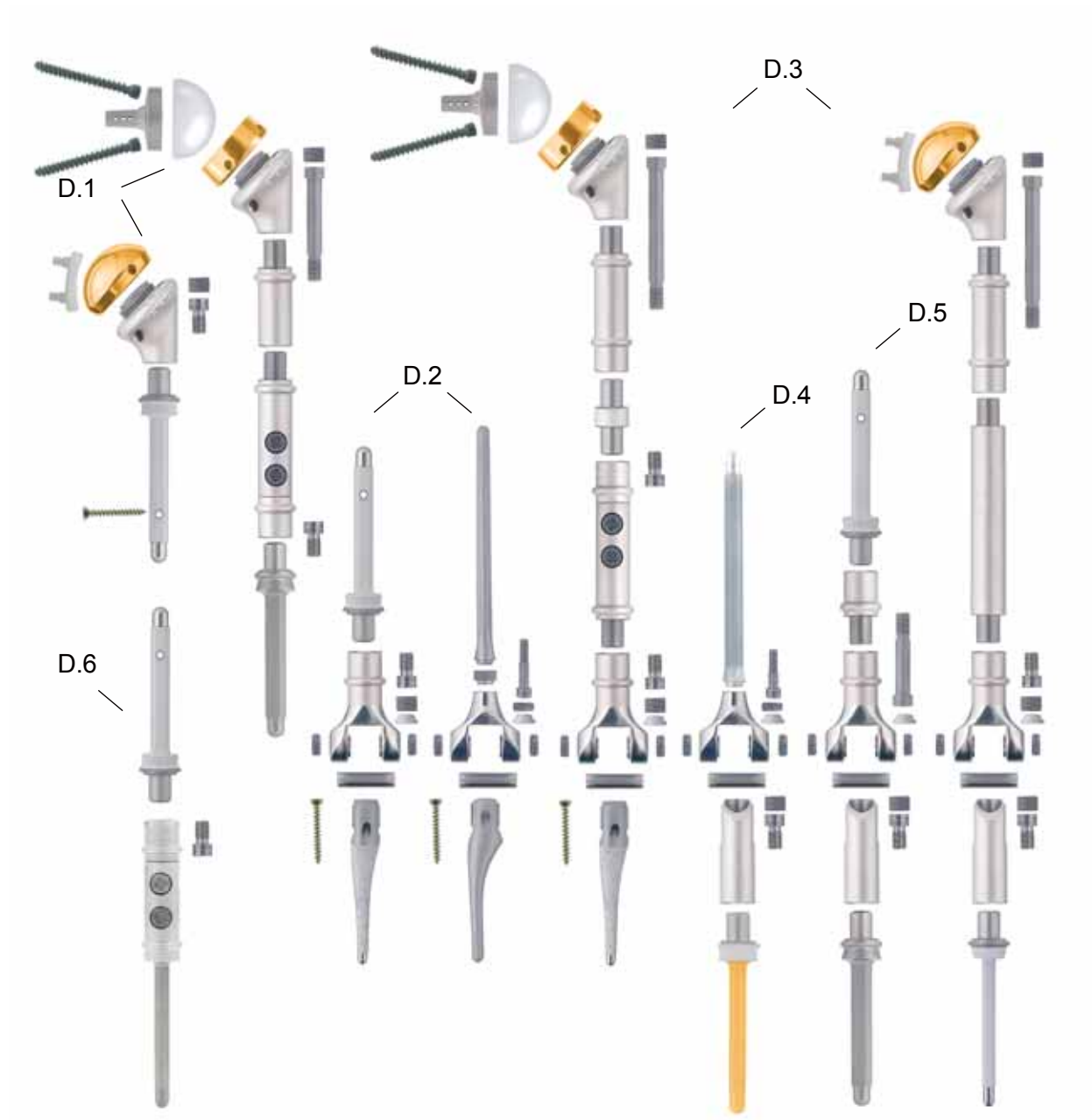

D Humeral Implants

- | | |
|----------------------------------|--|
| D.1 Proximal Humeral Replacement | Replacement of the proximal humerus (anatomic and inverse) |
| D.2 Distal Humeral Replacement | Replacement of the distal humerus (60mm or 30mm resection) |
| D.3 Total Humeral Replacement | Replacement of the entire humerus including joint components |
| D.4 Proximal Ulna Replacement | Replacement of the proximal ulna with 30mm Distal Humerus |
| D.5 Total Elbow Replacement | Replacement of the Elbow joint with humeral and ulnar components |
| D.6 Humeral Diaphyseal Implant | Diaphyseal reconstruction of humeral defect |



E Revision Implants

E.1 MUTARS® RS hip system

E.2 MUTARS® RS Arthrodesis

E.3 GenuX® knee system

E.4 GenuX® Intramedullary tot. Femoral Repl.

E.5 Knee Reconstruction Implant (KRI)

E.6 Intramedullary tot. Femoral Repl. with KRI

E.7 MUTARS® RS Cup

E.8 LUMiC®

Modular revision of the hip joint

Arthrodesis of the knee joint

Modular revision arthroplasty of the knee joint

Combined replacement of the hip and knee joint (revision)

Replacement of the distal femur (short resections)

Combined Replacement of hip and knee (loss of condyles)

Revision acetabular cup

Partial pelvic reconstruction

MUTARS® Proximal Femoral Replacement

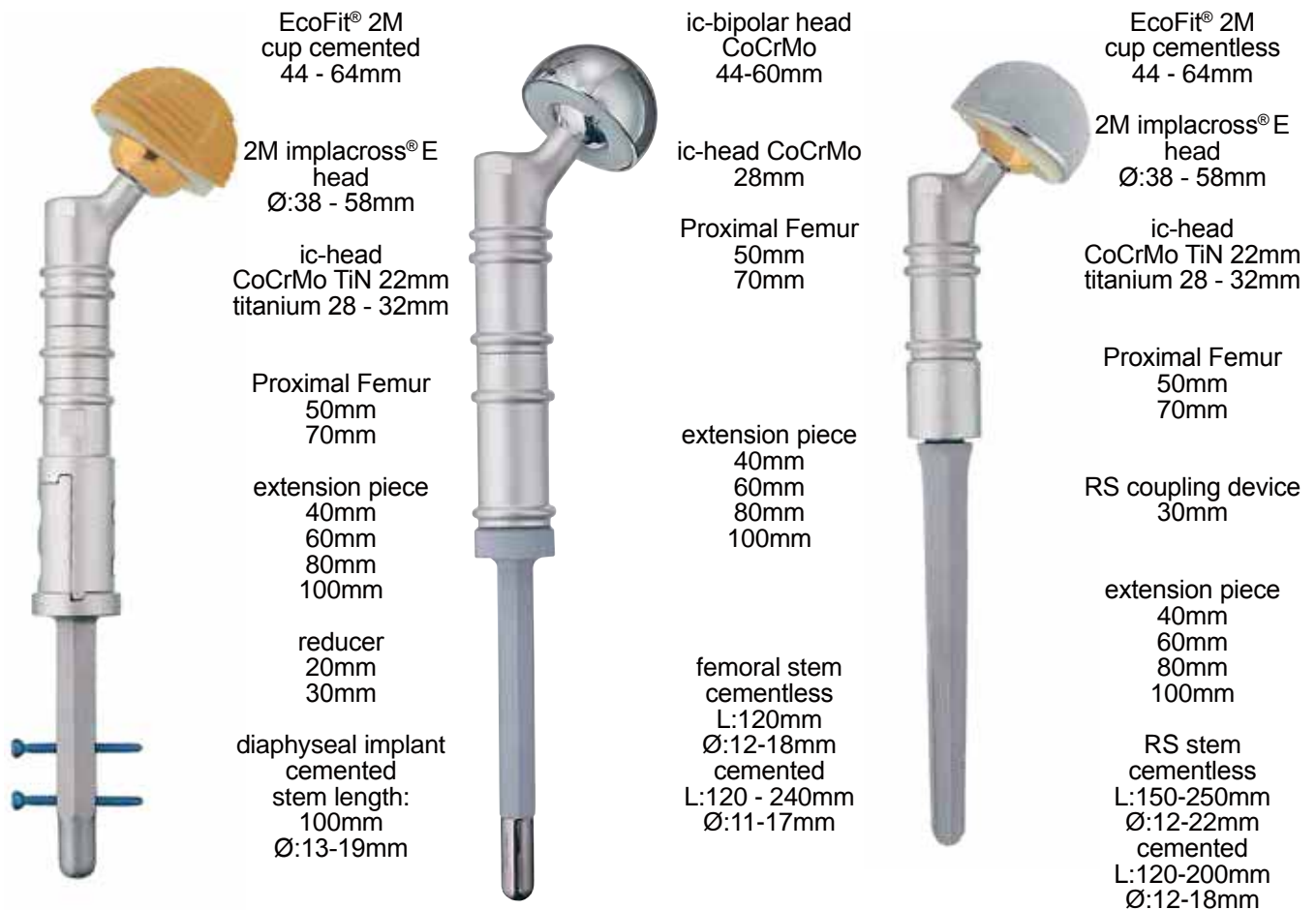

Proximal Femur with EcoFit® 2M cup cemented and diaphyseal implant

Proximal Femur with ic-bipolar head CoCrMo

Proximal Femur with EcoFit® 2M cup cementless, RS coupling device and RS stem

A.1 Proximal Femoral Replacement

Indication:

Tumours in the area of the proximal femur or other major bone defects including hip joint arthroplasty as hemi prosthesis or total hip replacement

System Components:

Proximal Femur in two different lengths of 50mm and 70mm with taper (12/14), with retention rings for fixation of the attachment tube, curved femoral stem in different diameters, cemented (CoCrMo) and cementless (TiAl₆V₄) with HA-coating, head: CoCrMo, ceramic (Al₂O₃ and ZrO₂) or TiAl₆V₄ with TiN-coating. The length of resection can be adjusted via the use of the extension pieces in 20mm increments. The Proximal Femur allows the adjustment of the version angle in 5° increments. All components allow the rotational adjustment of 5° increments, too.

Alternative fixation to the bone: with Diaphyseal Implant and connecting part, RS coupling device (30mm) and tapered RS stem as well as tapered, cementless stems

Length of reconstruction:

≥ 80mm

Materials:

implatan®, TiAl₆V₄, implavit®, CoCrMo, UHMW-PE, implacross E®; crosslinked UHMW-PE with vitamin E

MUTARS®

Proximal Femoral Replacement Revision



Proximal Femur Revision with
cementless femoral stem



Proximal Femur Revision with
cemented femoral stem

ic-head titanium
28 - 32mm

Proximal Femur Revision
50mm 127°
50mm 135°
70mm 127°
70mm 135°

femoral stem
cementless
L:120mm
Ø:12-18mm
cemented
L:120 - 240mm
Ø:11-17mm

A.1.1 Proximal Femoral Replacement Revision

Indication:

Tumours in the area of the proximal femur or other major bone defects including hip joint arthroplasty as hemi prosthesis or total hip replacement where retention of greater trochanter is possible

System Components:

Proximal femur revision in lengths of 50mm and 70mm, both with a choice of 127° and 135° CCD angle with taper (12/14), curved femoral stem in different diameters, cemented (CoCrMo) and cementless (TiAl₆V₄) with HA-coating, head: CoCrMo, ceramic (Al₂O₃ and ZrO₂) or TiAl₆V₄ mit TiN-coating. The length of resection can be adjusted via the use of the extension pieces in 20mm increments. The Proximal Femur allows the adjustment of the version angle in 5° increments. All components allow the rotational adjustment of 5° increments.

Alternative fixation to the bone: with Diaphyseal Implant and connecting part, RS coupling device (30mm) and tapered RS stem as well as tapered, cementless stems

Length of reconstruction:

≥ 80mm

Materials:

implatan®; TiAl₆V₄, implavit®, CoCrMo, implacross®; crosslinked UHMW-PE, implacross E®; crosslinked UHMW-PE with vitamin E

MUTARS® Distal Femoral Replacement MK

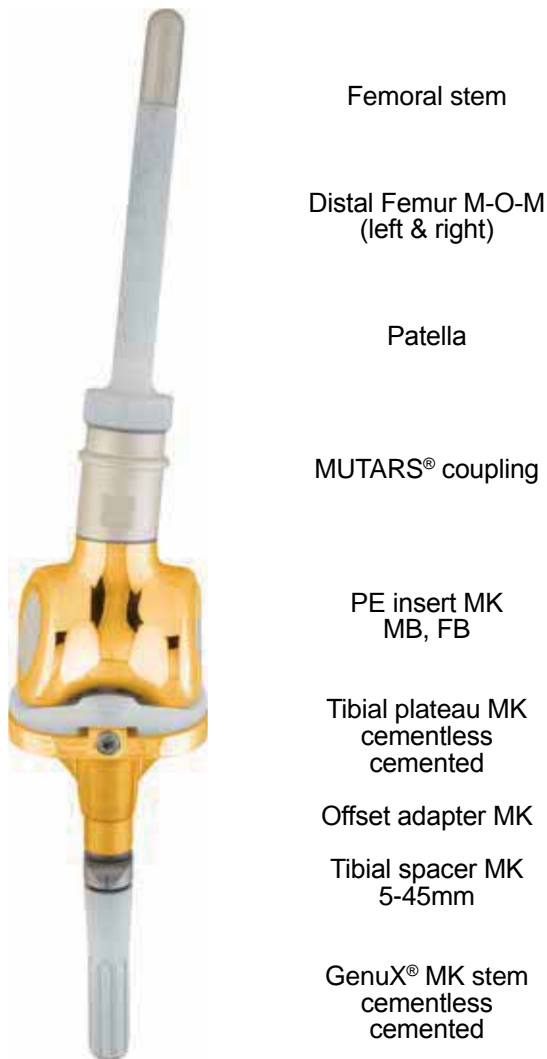

A.2 Distal Femoral Replacement MK

Indication:

Tumours in the area of the distal femur with a rotating hinge knee arthroplasty

System Components:

Distal Femur M-O-M 90mm and 110mm, PE insert MK, MUTARS® coupling, curved femoral stem, genuX® MK stem cemented or cementless, Tibial plateau MK cementless and cemented, cemented Patella replacement, Offset adapter MK

Length of reconstruction:

≥ 100mm

Materials:

implatan®, TiAl₆V₄
implavit®, CoCrMo
UHMW-PE

MUTARS® Distal Femoral Replacement MK with RS stem

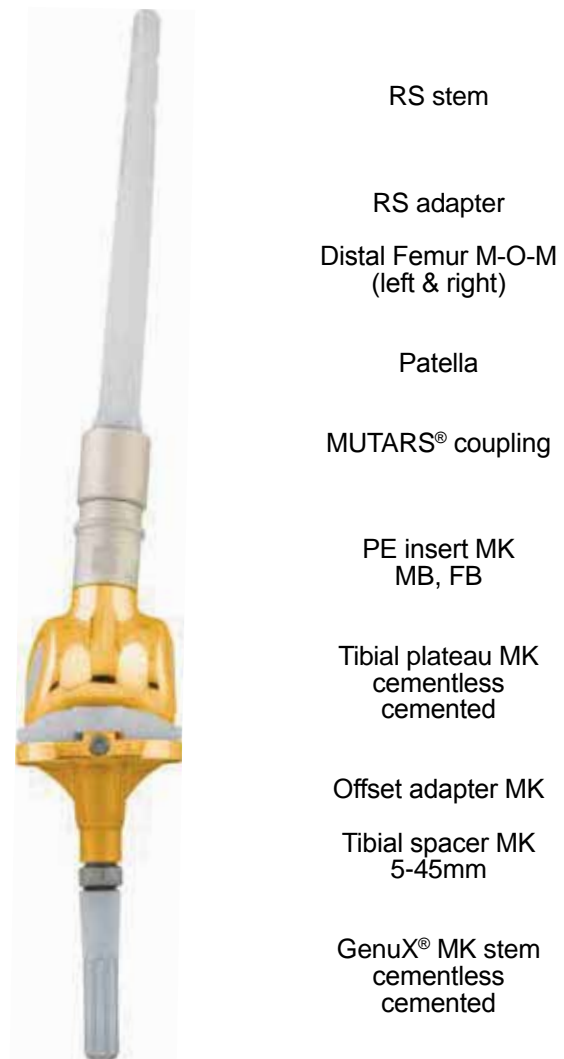

A. 3 Distal Femoral Repl. MK with RS stem

Indication:

Tumours in the area of the distal femur after extended extraarticular resections

System Components:

Distal Femur M-O-M 90mm and 110mm, RS Adapter, PE insert MK, MUTARS® coupling, curved femoral revision stem, genuX® MK stem cemented or cementless, Tibial plateau MK cementless and cemented, cemented Patella replacement, Offset adapter MK

Length of reconstruction:

≥ 120mm

Materials:

implatan®, TiAl₆V₄
implavit®, CoCrMo
UHMW-PE

MUTARS® Total Femoral Replacement MK



EcoFit® 2M cup cementless
 2M implacross® E head
 ic-head TiN
 Proximal Femur
 Extension piece
 connecting part
 reducer
 Distal Femur M-O-M
 MUTARS® coupling
 PE insert MK
 MB, FB
 Tibial plateau MK
 cementless
 cemented
 Offset adapter MK
 Tibial spacer MK
 5-45mm
 GenuX® MK stem
 cementless
 cemented

A.4 Total Femoral Replacement MK

Indication:

Tumours throughout the entire femoral bone with replacement of the hip and knee joint
 The reconstruction length can be adjusted in 10mm increments.

System Components:

Proximal Femur, Head: CoCrMo, Ceramic or TiN, 2M implacross® E head, EcoFit® 2M Cup, Distal Femur M-O-M, PE insert MK, MUTARS® coupling, Connecting part, Reducer, Tibial plateau MK, Offset adapter MK, GenuX® MK stem

Length of reconstruction:

≥ 280mm

Materials:

implatan®; TiAl₆V₄
 implavit®; CoCrMo
 UHMW-PE, implacross E®; crosslinked UHMW-PE with vitamin E, Al₂O₃ and ZrO₂

MUTARS® Prox. Fem. Replacement with Revision Knee GenuX® MK



EcoFit® 2M cup cementless
 2M implacross® E head
 ic-head titanium
 Proximal Femur
 RS adapter
 30mm
 Intramedullary connecting
 module GenuX® MK
 GenuX® MK Femur
 (left & right)
 size.:2-5
 MUTARS® coupling
 PE insert MK
 MB, FB
 Tibial plateau MK
 cementless
 cemented
 Offset adapter MK
 Tibial spacer MK
 5-45mm
 GenuX® MK stem
 cementless
 cemented

A.5 Prox. Femoral Repl. with Revision Knee GenuX® MK

Indication:

Tumours in the area of the proximal femur.
 Intramedullary connection to a revision knee

System Components:

Proximal Femur, Head: CoCrMo, Ceramic or TiAl₆V₄ with TiN-coating, 2M implacross® E head, EcoFit® 2M Cup, RS adapter, IMFR GenuX® MK, GenuX® MK femoral component, PE insert MK, MUTARS® coupling, Tibial plateau MK, Offset adapter MK, GenuX® MK stem

Implant length:

≥ 260mm (prox. reconstruction ≥ 100mm)

Materials:

implatan®; TiAl₆V₄
 implavit®; CoCrMo
 UHMW-PE
 implacross E®; crosslinked UHMW-PE with vitamin E

MUTARS® Total Knee Replacement MK with Distal Femur or KRI

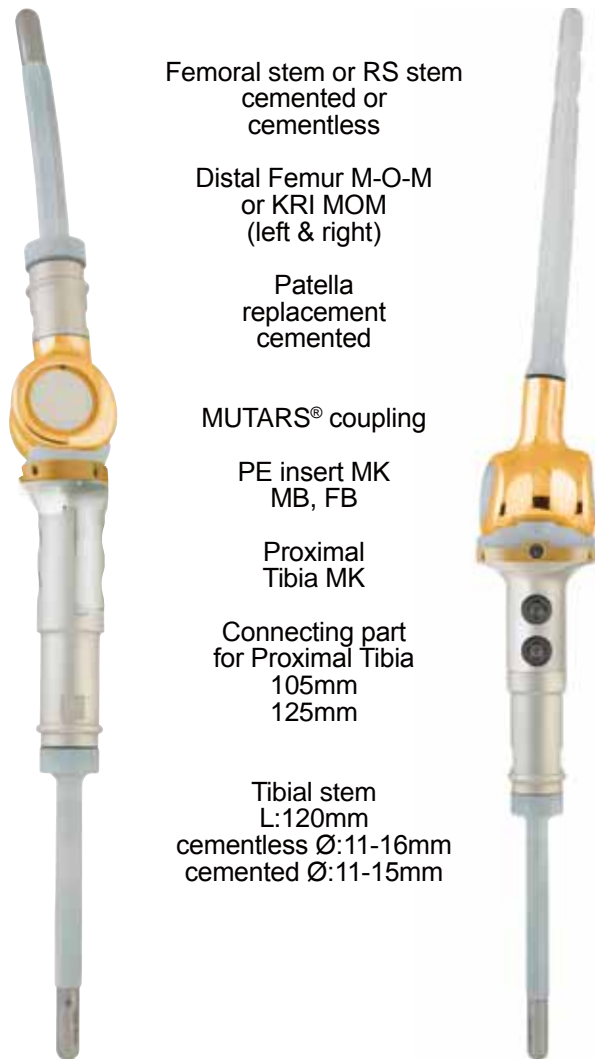

Femoral stem or RS stem
cemented or
cementless

Distal Femur M-O-M
or KRI MOM
(left & right)

Patella
replacement
cemented

MUTARS® coupling

PE insert MK
MB, FB

Proximal
Tibia MK

Connecting part
for Proximal Tibia
105mm
125mm

Tibial stem
L:120mm
cementless Ø:11-16mm
cemented Ø:11-15mm

B.1 Total Knee Replacement MK with Distal Femur or KRI

Indication:

Tumours in the area of the knee joint with major femoral and tibial bone loss - rotating hinge knee arthroplasty

System Components:

Femoral stem, Distal Femur M-O-M or KRI MOM, MUTARS® coupling, Proximal Tibia MK, PE insert MK, Connecting part for Proximal Tibia MK, Tibial stem cemented and cementless, cemented patella replacement

Length of reconstruction:

with Distal Femur ≥ 215mm
(femoral 100mm, tibial 115mm),
with KRI ≥ 165mm
(femoral 50mm, tibial 115mm)

Materials:

implatan®; TiAl₆V₄; implavit®; CoCrMo
UHMW-PE

MUTARS® Proximal Tibia MK Replacement



GenuX® MK stem
cementless
cemented

Offset adapter MK

GenuX® MK
femoral component
(left & right)
cementless
cemented

Patella
replacement
cemented

MUTARS® coupling

PE insert MK
MB, FB

Proximal
Tibia MK

Connecting part
for Proximal Tibia MK
105mm
125mm

Tibial stem
L:120mm
cemented Ø:11-15mm
cementless Ø:12-16mm

B.2 Proximal Tibia MK Replacement

Indication:

Tumours in the area of the proximal tibia with a rotating hinge femoral resurfacing knee replacement

System Components:

GenuX® MK stem, GenuX® MK femoral components, Proximal Tibia MK, PE insert MK size 2, MUTARS® coupling, Connecting part for Proximal Tibia MK, Tibial stem cemented and cementless, cemented patella replacement

Length of reconstruction:

≥ 115mm

Materials:

implatan®; TiAl₆V₄
implavit®; CoCrMo
UHMW-PE

MUTARS® Arthrodesis Implant

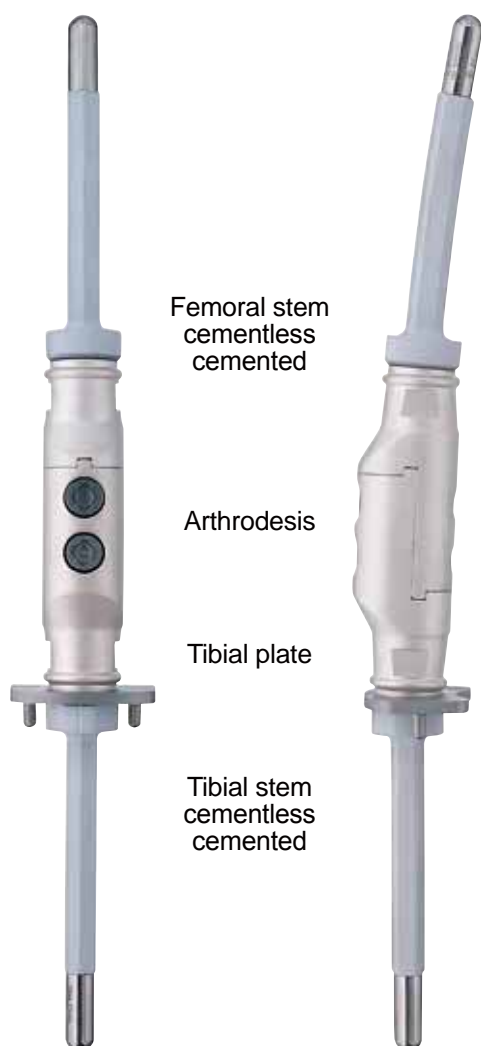

C.1 Arthrodesis Implant

Indication:

Tumours in the area of the knee joint. Arthrodesis of the knee joint

System Components:

Femoral stem, Arthrodesis, tibial plate, tibial stem cementless or cemented

Length of reconstruction:

≥ 145mm

Materials:

implatan®; TiAl₆V₄
implavit®; CoCrMo
UHMW-PE

MUTARS® Diaphyseal Implant

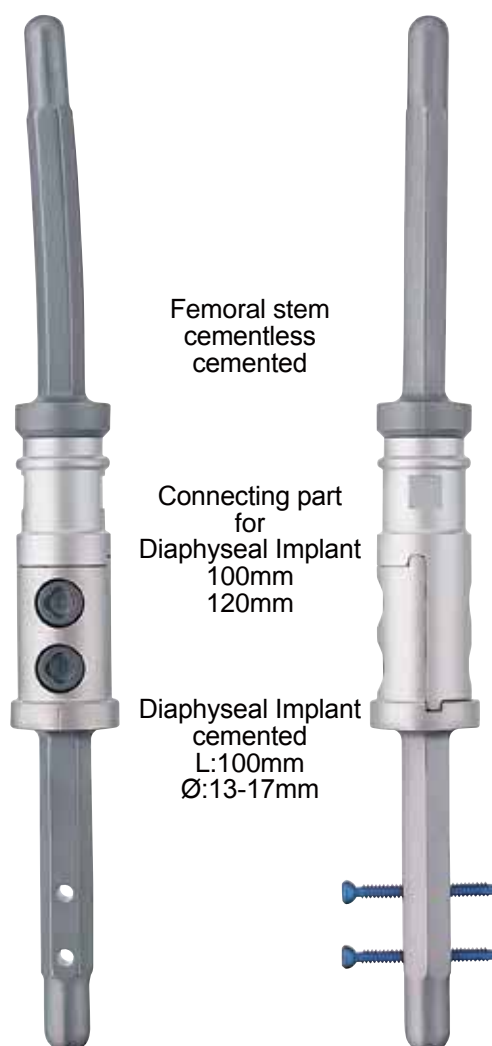

C.2 Diaphyseal Implant

Indication:

Tumours in the area of the femoral or tibial diaphysis - the Diaphyseal Implant should be orientated always towards the nearest joint. An interlocking with screws is recommended.

System Components:

Diaphyseal Implant with stem (cemented), connecting part for Diaphyseal Implant, femoral or tibial stems cemented or cementless- can be used cemented

Length of reconstruction:

≥ 100mm

Materials:

implatan®; TiAl₆V₄
implavit®; CoCrMo
UHMW-PE

MUTARS® Proximal Humeral Replacement

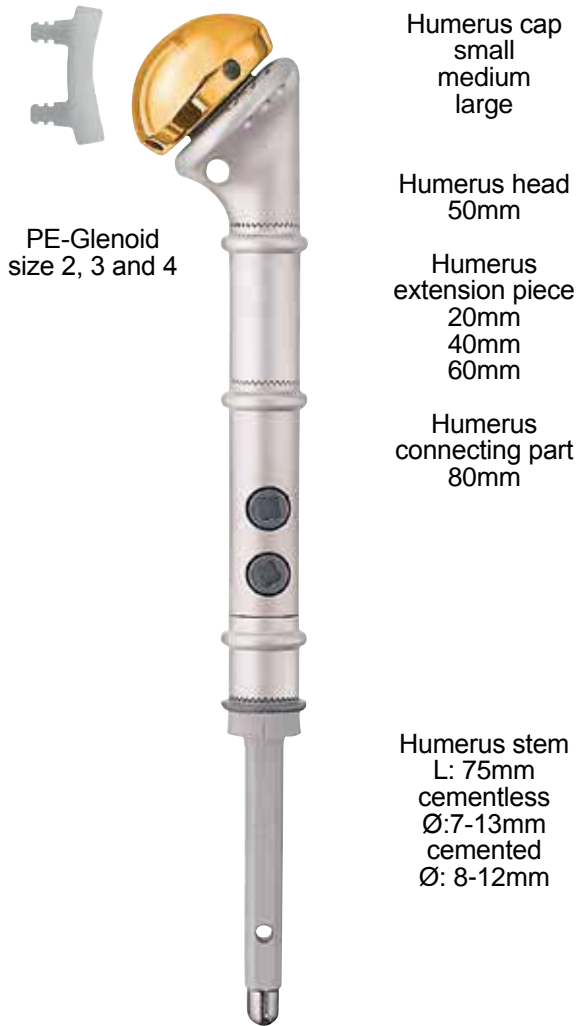

The MUTARS® Humeral Components

The special system for the upper extremity offers the opportunity of a proximal, distal or total humeral reconstruction. The modular humeral caps are available in three different sizes and allow an optimal glenoid contact. The small head and the slightly medialized geometry provide improved soft tissue coverage. As an intraoperative option there are inverse humeral components available including an inverse Humerus cap and glenoid replacement. The design of the extension pieces allows for an intraoperative adjustment in length of 20mm increments. The modular construction allows the surgeon to treat the whole upper extremity with one universal system. If necessary, the implant may be extended intraoperatively to a total humerus prosthesis, thus providing an optimal solution to the individual requirements of each single case.

MUTARS® Proximal Humeral Replacement Inverse

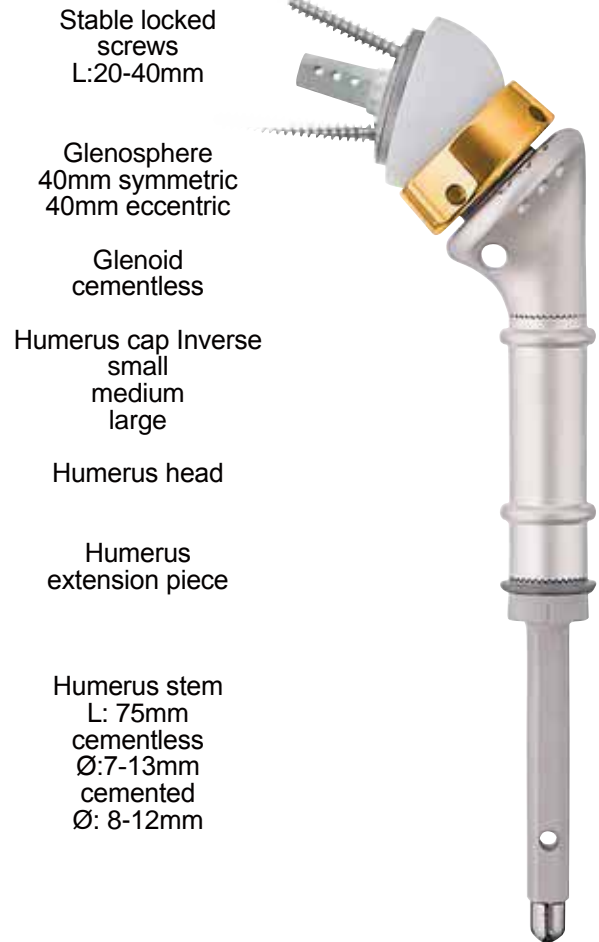

D.1 Proximal Humeral Replacement and Humeral Replacement Inverse

Indication:

Tumours in the area of the proximal humerus or bone defects after fracture or revision surgery -with the inverse option in case of rotator cuff insufficiencies.

System Components:

Humerus head, Humerus cap, Humerus inverse cap, Humerus connecting part and Humerus extension piece, glenoid and glenosphere, PE-glenoid, cancellous screws 4mm, stable lock screws 4,2mm, Humerus stem cementless (TiAl₆V₄) and cemented (CoCrMo)

Length of reconstruction:

≥ 60mm

Materials:

implatan®; TiAl₆V₄

implavit®; CoCrMo, pure titanium, UHMW-PE

MUTARS® Distal Humeral Replacement

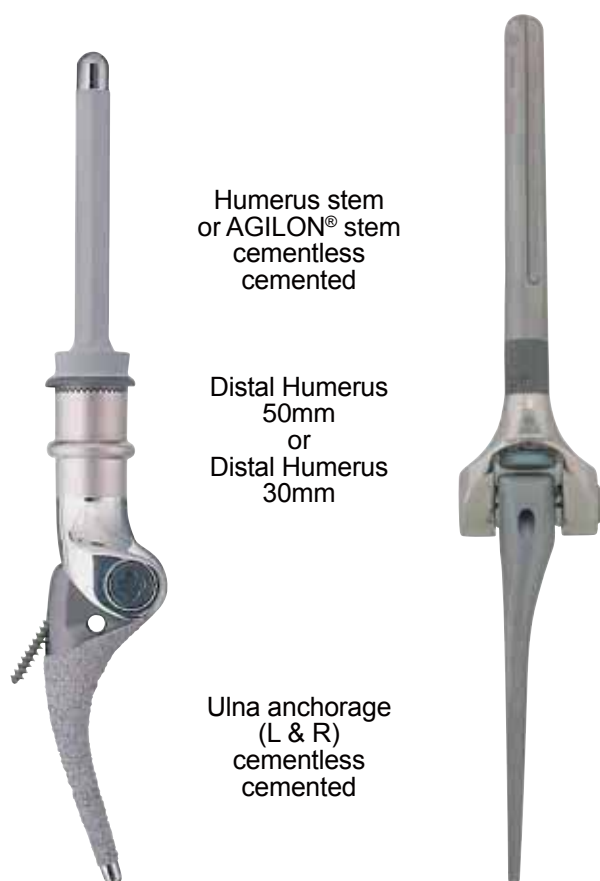

Humerus stem
or AGILON® stem
cementless
cemented

Distal Humerus
50mm
or
Distal Humerus
30mm

Ulna anchorage
(L & R)
cementless
cemented

D.2 Distal Humeral Replacement

Indication:

Tumours in the area of the distal humerus with a constrained replacement of the humeroulnar joint

System Components:

Distal Humerus 50mm or 30mm, Humerus and AGILON® stem cementless (TiAl₆V₄) and cemented (CoCrMo), Ulna anchorage: cementless (TiAl₆V₄) and cemented (CoCrMo), The combination with the Proximal Ulna is possible and described in chapter D.4.

Length of reconstruction:

≥ 60mm (30mm if the Distal Humerus 30mm is used)

Materials:

implatan®; TiAl₆V₄
implavit®; CoCrMo
UHMW-PE

MUTARS® Total Humeral Replacement



Humerus cap

Humerus head

Humerus
reducer
10mm
100mm

Humerus
extension piece

Humerus
connecting part

Distal Humerus

Ulna anchorage
(L & R)
cementless
cemented

D.3 Total Humeral Replacement

Indication:

Extensive tumours of the humerus, partial replacement of the shoulder joint, constrained arthroplasty of the humeroulnar joint

System Components:

Humerus cap, Humerus head, reducer, extension piece and Humerus connecting part, Ulna anchorage: cementless (TiAl₆V₄) and cemented (CoCrMo),

The combination with the Proximal Ulna is possible and described in chapter D.4.

Length of reconstruction:

≥ 190mm

Materials:

implatan®; TiAl₆V₄
implavit®; CoCrMo
UHMW-PE

MUTARS® Proximal Ulnar Replacement

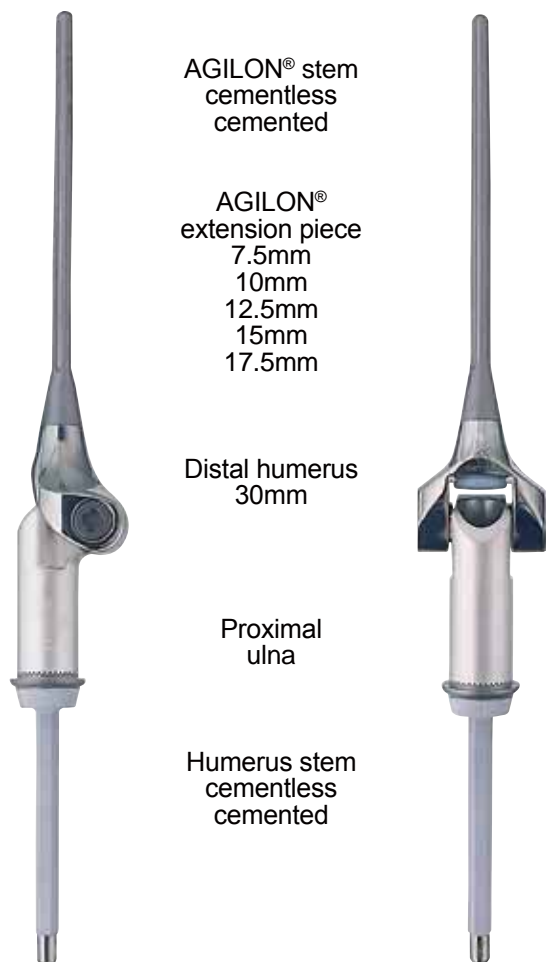

D.4 Proximal Ulnar Replacement

Indication:

Tumours in the area of the proximal ulna with a constrained replacement of the humeroulnar joint

System Components:

Distal Humerus 30mm, Proximal Ulna (TiAl₆V₄), AGILON® stem cemented and cementless, AGILON® extension piece, humerus stem: cementless (TiAl₆V₄) and cemented (CoCrMo),

Length of reconstruction:

≥ 60mm ulnar

Materials:

implatan®; TiAl₆V₄
implavit®; CoCrMo
UHMW-PE

MUTARS® Total Elbow Replacement/Diaphyseal Implant

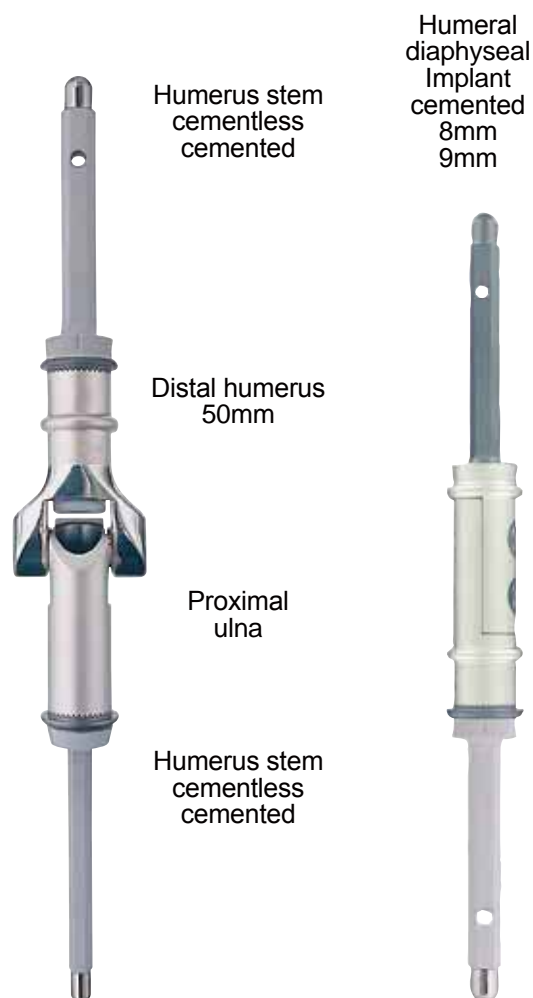

D.5 Total Elbow Replacement

Indication:

Tumours in the area of the distal humerus and the proximal ulna with a constrained replacement of the humeroulnar joint.

System Components:

Distal Humerus, Proximal Ulna (TiAl₆V₄), humerus stem: cementless (TiAl₆V₄) and cemented (CoCrMo),

Length of reconstruction:

≥ 60mm (ulnar and humeral)

Materials:

implatan®; TiAl₆V₄
implavit®; CoCrMo, UHMW-PE

D.6 Humeral Diaphyseal Implant

Indication:

Tumours in the area of the humeral diaphysis. The cemented Diaphyseal Implant (8 and 9mm) should be orientated towards the nearest joint.

MUTARS® RS Hip Revision System

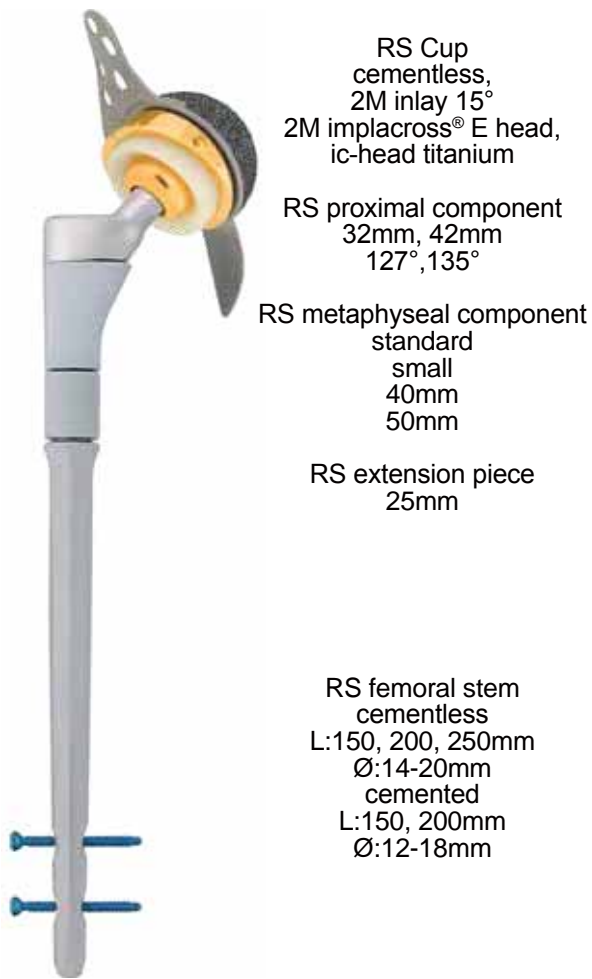

RS Cup
cementless,
2M inlay 15°
2M implacross® E head,
ic-head titanium

RS proximal component
32mm, 42mm
127°, 135°

RS metaphyseal component
standard
small
40mm
50mm

RS extension piece
25mm

RS femoral stem
cementless
L:150, 200, 250mm
Ø:14-20mm
cemented
L:150, 200mm
Ø:12-18mm

MUTARS® RS Arthrodesis Implant

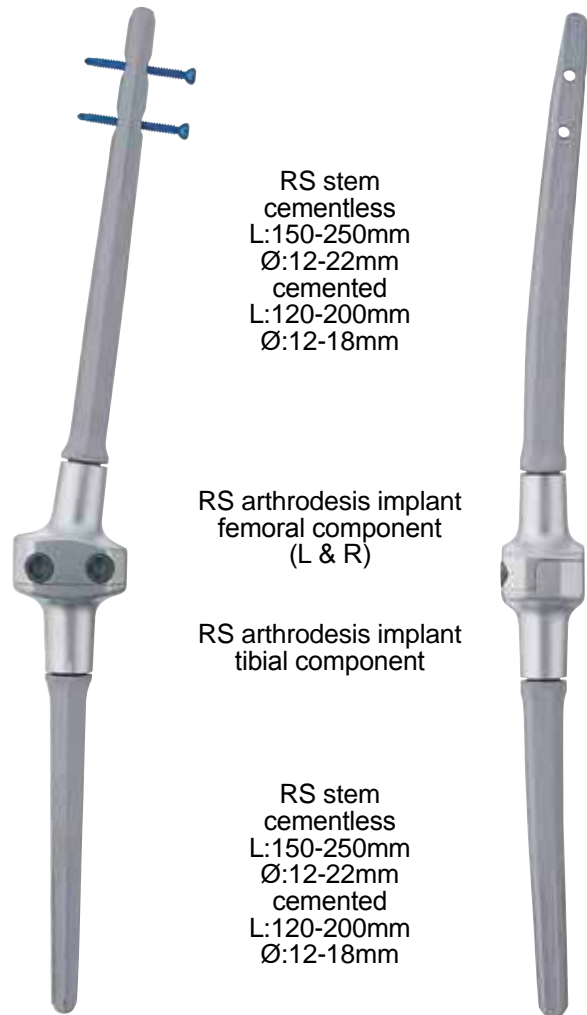

RS stem
cementless
L:150-250mm
Ø:12-22mm
cemented
L:120-200mm
Ø:12-18mm

RS arthrodesis implant
femoral component
(L & R)

RS arthrodesis implant
tibial component

RS stem
cementless
L:150-250mm
Ø:12-22mm
cemented
L:120-200mm
Ø:12-18mm

E.1 MUTARS® RS Revision Hip Replacement

Indication:

Revision of the hip joint

System Components:

RS cup, 2M inlay 15°, 2M implacross® E head, ic-head TiN, RS proximal component, RS metaphyseal component, RS extension piece 25mm, RS stem cementless (TiAl₆V₄) with HA-coating and cemented (CoCrMo), alternatively the extra small RS stems can be used (direct combination to the proximal part without metaphyseal part)

Implant length:

≥ 220mm, proximal reconstruction ≥ 72mm (32mm if extra small RS stems is used)

Materials:

implatan®, TiAl₆V₄, implavit®, CoCrMo, implacross®, crosslinked UHMW-PE, implacross E®, crosslinked UHMW-PE with Vitamin E, UHMW-PE

E.2 MUTARS® RS Arthrodesis

Indication:

Arthrodesis with possible cementless fusion of the knee joint

System Components:

RS arthrodesis implant femoral component (TiAl₆V₄), RS arthrodesis implant tibial component (TiAl₆V₄), RS stem cementless (TiAl₆V₄) and cemented (CoCrMo),

Length of reconstruction:

≥ 90mm (30mm, if the stem connecting portions are inserted into the bone)

Materials:

implatan®, TiAl₆V₄
implavit®, CoCrMo
UHMW-PE

GenuX® MK Knee Revision System



GenuX® MK stem
cementless
cemented

Offset adapter MK

Femoral spacer
cemented

GenuX® MK
femoral component
(left&right)
cementless
cemented

Patella
replacement
cemented

MUTARS® coupling

PE insert MK
MB, FB

Tibial Plateau MK
cementless
cemented

Tibial spacer MK

Offset adapter MK

GenuX® MK stem
cementless
cemented

E.3 GenuX® MK Knee Revision System

Indication:

Constrained revision knee replacement, large bone defects can be augmented

System Components:

GenuX® MK femoral component, GenuX® MK stem cementless and cemented, Tibial plateau MK cementless and cemented, Offset adapter MK, PE insert MK, MUTARS® coupling

Implant length:

≥ 120mm tibial and femoral, augmentation:
5-20mm tibial unicondylar, 25-45mm tibial bicondylary, femoral 5 and 10mm,

Materials:

implatan®; TiAl₆V₄
implavit®; CoCrMo
UHMW-PE

GenuX® MK Monoblock



GenuX® MK Monoblock
femoral component
(left&right)
cemented

Patella
replacement
cemented

MUTARS® coupling

PE insert MK
MB, FB

Tibial plateau MK
Monoblock
cemented

E.3.1 GenuX® MK Monoblock

Indication:

Coupled, cemented revision treatment of the knee without major bone defects

System Components:

GenuX® MK Monoblock femoral component cemented, Tibial plateau MK Monoblock cemented, PE insert MK, MUTARS® coupling

Length of reconstruction:

≥ 125mm tibial und femoral

Materials:

implatan®; TiAl₆V₄
implavit®; CoCrMo
UHMW-PE

GenuX[®] MK Revision System



Fig. 9: GenuX[®] MK offset
femoral / tibial

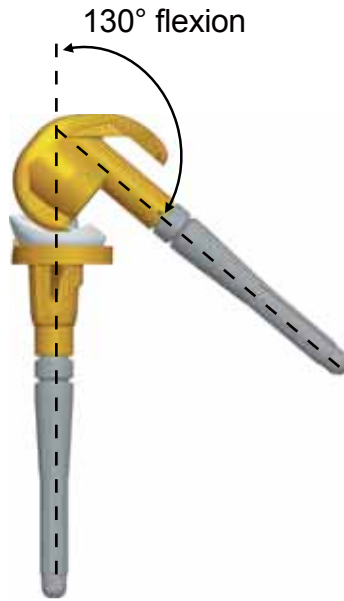

Fig. 10: GenuX[®] MK flexion

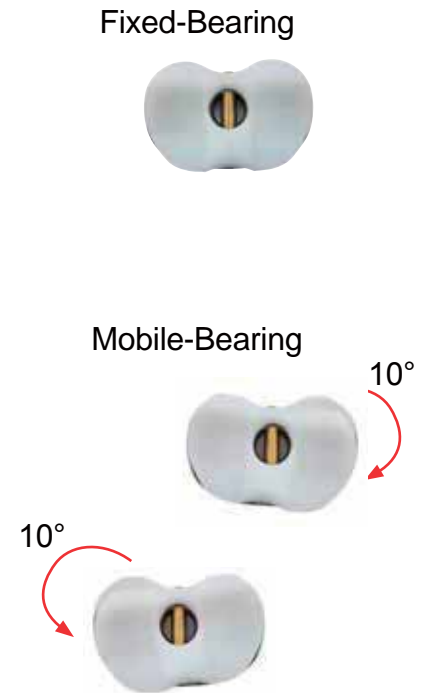

Fig. 11: GenuX[®] MK PE insert
MB and FB

The GenuX[®] MK (Modular Knee)

The GenuX[®] MK is a further development of the existing GenuX[®] revision knee implant. The modular design coupled with the 360° freely rotating offset male-male double taper offset adapter makes it possible for the same range(s) of cemented or cementless femoral or tibial stems to be utilised. The new design of the femoral component allows 130° of flexion. The newly designed femoral component features a greatly reduced intercondylar box that preserves much more of the intercondylar bone. The thickness of the new tibial plateau is reduced by 2.5mm and this allows the intraoperative choice of mobile bearing PE with a possible 20° rotation and fixed bearing PE which is the same as the GenuX[®]. The tibial plateau was designed with reference to the ACS[®] SC geometry which allows implantcast the opportunity to seamlessly consolidate the instrument platform to allow the surgeon to change from a planned ACS[®] SC to a fully coupled knee prosthesis. The new system will incorporate the use of tibial and femoral spacers. The femoral components will allow independent posterior and distal spacer placement. The new system has four femoral and tibial sizes that are freely combinable and available in uncemented and cemented version.

The new GenuX[®] MK has the following features:

- fully constrained rotating knee
- MB and FB option
- Max. 20° rotation (MB)
- cemented and cementless
- 360° freely adjustable offset
- Offset of 2mm, 4mm and 6mm
- fixation of femoral spacers (5-10mm) and tibial spacers (5 - 45mm)
- 5 femoral and tibial sizes
- full compatibility to MUTARS[®]
- combinable with the EPORE[®] Defect filler

GenuX® MK Intramedullary Total Femoral Replacement



- ic-bipolar head
- ic-head
- RS proximal component
- RS metaphyseal component
 - standard
 - small
- Intramedullary connecting module GenuX® MK
- Offset adapter MK
- GenuX® MK femoral component (L & R)
 - cementless
 - cemented
- MUTARS® coupling
- PE insert MK
 - MB, FB
- Tibial plateau MK
 - cementless
 - cemented
- Tibial spacer MK
- Offset adapter MK
- GenuX® MK stem
 - cementless
 - cemented

E.4 GenuX® MK Intramedullary Total Femoral Replacement

Indication:

Combined revision joint replacement of the hip and knee joint using an intramedullary connection

System Components:

RS proximal component, RS metaphyseal component, RS Extension piece 25mm, Intramedullary connecting module, Offset adapter MK, GenuX® MK femoral component, Tibial plateau MK, GenuX® MK stem cementless and cemented, PE insert MK, MUTARS® coupling

Length of reconstruction:

≥ 332mm (femoral length)

Materials:

implatan®; TiAl₆V₄
implavit®; CoCrMo
UHMW-PE

KRI MK - Knee Reconstruction Implant



- RS stem
 - cementless
 - cemented
- KRI M-O-M (L & R)
- MUTARS® coupling
- PE insert MK
 - MB, FB
- Tibial plateau MK
 - cementless
 - cemented
- Tibial spacer MK
- Offset adapter MK
- GenuX® MK stem
 - cementless
 - cemented



E.5 KRI MK - Knee Reconstruction Implant

Indication:

Constrained revision knee replacement, huge bone defects can be augmented with loss of the distal femoral condyles

System Components:

RS stem, RS extension piece 25mm, KRI M-O-M (for allergic patients also TiN coated), Tibial plateau MK cemented, Offset adapter MK, GenuX® MK stem cementless and cemented, PE insert MK, MUTARS® coupling

Length of reconstruction:

≥ 50mm

Materials:

implatan®; TiAl₆V₄
implavit®; CoCrMo
UHMW-PE

Intramedullary Total Femoral Replacement KRI MK

MUTARS® LUMiC®



EcoFit® 2M cup cemented
2M implacross® E head
ic-head TiN

RS proximal component

RS metaphyseal component
standard
small

Intramedullary
connecting module
for KRI
Ø:15mm
cementless

KRI M-O-M
(L & R)

MUTARS® coupling

PE insert MK
MB, FB

Tibial plateau MK
cementless
cemented

Tibial spacer MK

Offset adapter MK

GenuX® MK stem
cementless
cemented

E.6 Intramedullary Total Femoral Repl. with KRI MK

Indication:

Combined revision joint replacement of the hip and knee joint using an intramedullary connection with loss of the distal femoral condyles

System Components:

RS proximal component, RS metaphyseal component, RS extension piece 25mm, Intramedullary connecting module, KRI M-O-M, Tibial plateau MK, Offset adapter MK, GenuX® MK stem cemented and cementless, PE insert MK, MUTARS® coupling

Length of reconstruction:

≥ 327mm (femoral length)

Materials:

implatan®, TiAl₆V₄, implavit®, CoCrMo
UHMW-PE, implacross E®; crosslinked
UHMW-PE with vitamin E



LUMiC® Cup
3 sizes
HA-coated
smooth surface
silver (only 60mm cup)

LUMiC® stems
cementless
cemented



3 articulation options
-poly-on-metal
-poly-on-ceramic
-tripolar

B.8 Partial Pelvic Replacement using the LUMiC®

Indication:

Partial pelvic reconstruction replacement for the hip joint after many or complicated revisions or after major bone defects of the acetabulum

System Components:

LUMiC® cup (TiAl₆V₄), cementless (TiAl₆V₄) and cemented (CoCrMo) stems, 2M inlay 15° (CoCrMo with TiN-coating), implacross® PE-Insert (UHMW-PE), 2M implacross® E Head (UHMW-PE loaded with Vitamin E)

Materials:

implatan®, TiAl₆V₄
implavit®, CoCrMo
implacross®; crosslinked UHMW-PE,
implacross E®; crosslinked UHMW-PE
with vitamin E
UHMW-PE

MUTARS® Biopsy Punch

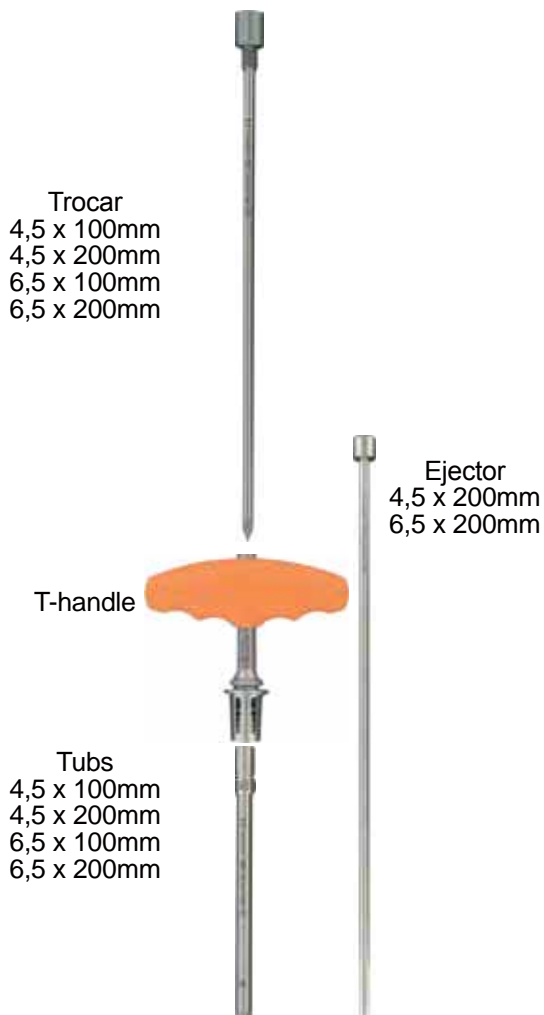

MUTARS® biopsy punch

Indication:

Sampling to identify undefined bone tumours or for sampling of bone

System Components:

ic T-handle WEB.c coupling, MUTARS® biopsy punch trocar, MUTARS® biopsy punch ejector, MUTARS® biopsy punch tubs.

Instrument length:

trocar (Ø 4,5 / 6,5mm in 100 / 200mm length)

tubs (Ø 4,5 / 6,5mm in 100 / 200mm length)

ejector (Ø 4,5 x 200 und Ø 6,5 x 200mm)

Compatibility:

ic-vac cement system

Material:

Stainless steel

Flexible Drill Nitinol

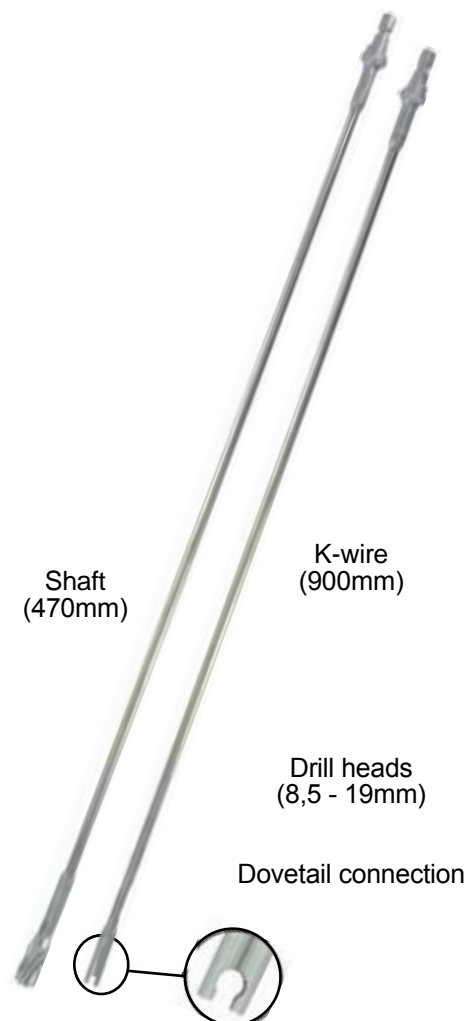

Flexible drill Nitinol

Indication:

Drilling of curved bones (e.g. femur)

System Components:

Shaft (l = 470mm)

Drill heads

(Ø 8,5 -19mm in 0,5mm increments)

k-wire (l = 900mm)

Material:

Nitinol

Stainless steel

MUTARS® Attachment tube

Length: 300mm
Ø:35mm + 55mm

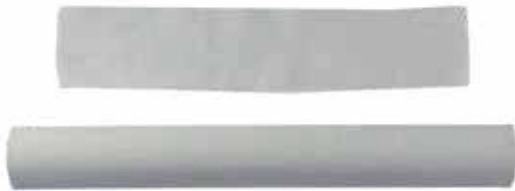

C.3 Attachment tube

Indication: The MUTARS® Attachment tube allows the fixation of muscle tissue and ligaments and assists the reconstruction of the joint capsule which helps prevent dislocation after major hip and shoulder surgery. In e.g. proximal tibial replacement the tube allows attachment of muscle flaps (e.g. gastrocnemius), the extensor apparatus as well as the patella ligament.

Length: 300mm

Material:

Polyethylenterephthalat (PET), available in two diameters of 35mm and 55mm



The retention rings of the MUTARS® components allow a safe fixation of the Attachment tube. It is recommended to start the fixation of the tube always at the proximal part.



Also the fixation holes of the MUTARS® proximal tibia allow a safe fixation of the Attachment tube.



In order to provide for maximum stability, fixation is applied under tension, using non-absorbable suture material.



The suture should be guided at least three times through the tube material and should finally be sutured applying several surgical knots.

In order to achieve maximum stability, all retention rings can be provided with two fixing-sutures, one above and one below the retention rings.

MUTARS® Xpand Mechanical Growing Prostheses

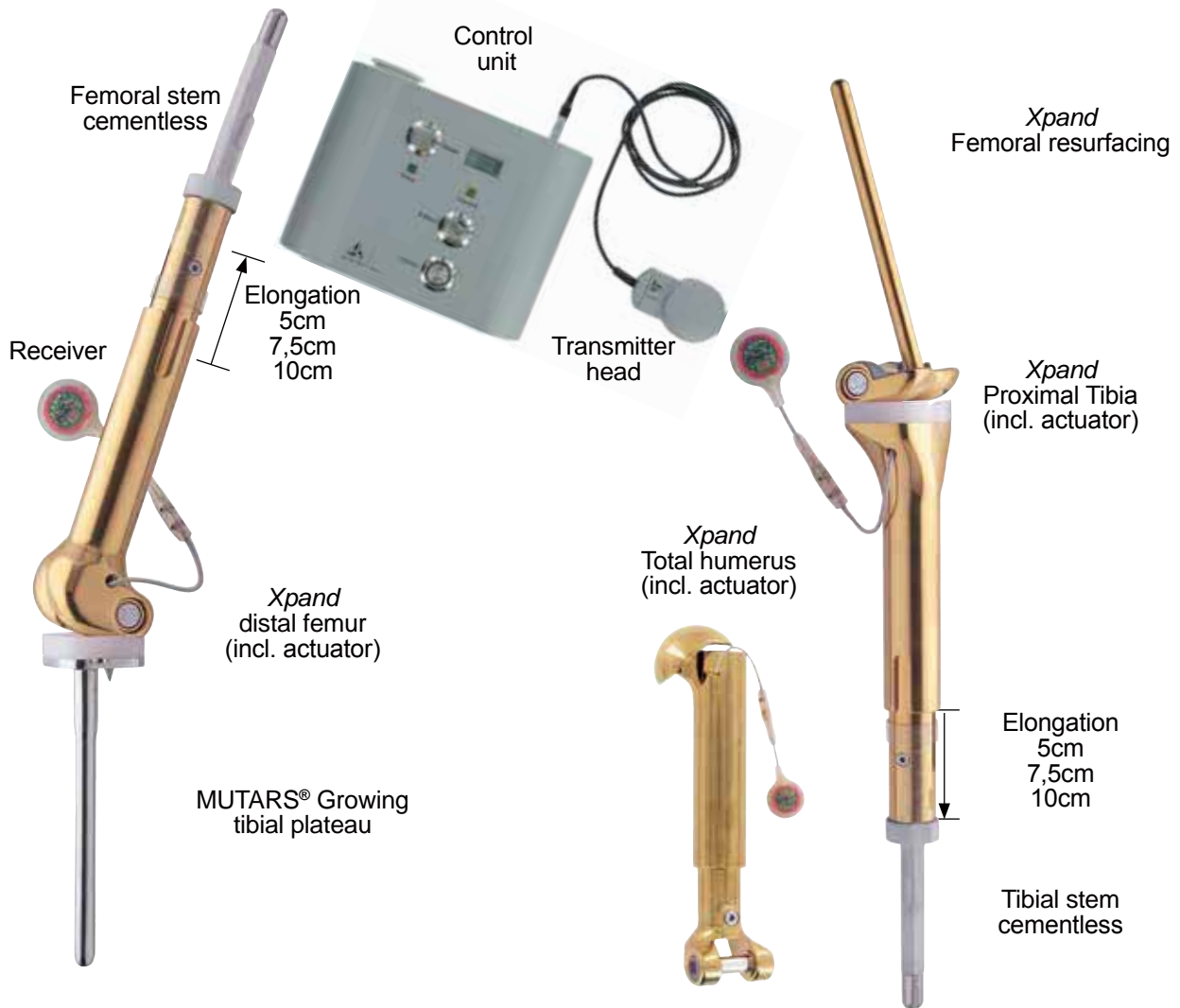

MUTARS® Xpand Growing Prostheses

The endoprosthetic treatment of pre-adolescent tumour patients is a challenging procedure for the surgeon as well as for the implant. The intramedullary fixation of the prosthetic components leads to reduced growth of the treated extremity and leading to limb length discrepancies. Most of the available systems include lengthening modules which are elongated mechanically during surgical procedures. In order to reduce the exposure of the patients to several surgeries and rising the risk of infection, the MUTARS® Growing Prosthesis follows a new concept. Based on an idea of Prof. Dr. R. Baumgart (Limb Lengthening Center Munich, ZEM-Germany) and in close collaboration with the company WITTENSTEIN intens GmbH (Igersheim) two new product systems (mechanical and biological) of growing prostheses have been developed.

The elongation of the Prosthesis, using the MUTARS® Xpand Prosthesis

The mechanical, non-invasive growing modules of the MUTARS® Xpand using a miniaturized, mechatronic actuator inside the prosthesis which is activated by energy coupling from outside the skin. An additional invasive surgery is not necessary, which reduces the risk of infection (Elongation 5cm: reconstruction length 170mm/ 7,5cm: 195mm/10cm:220mm).

After the lengthening procedure the Xpand components are replaced by regular MUTARS® components.

NB: All components of the MUTARS® Xpand Growing Prostheses are customised implants which are planned, designed and manufactured for each patient based on a scaled x-ray.

MUTARS® BioXpand Biological Growing Prostheses

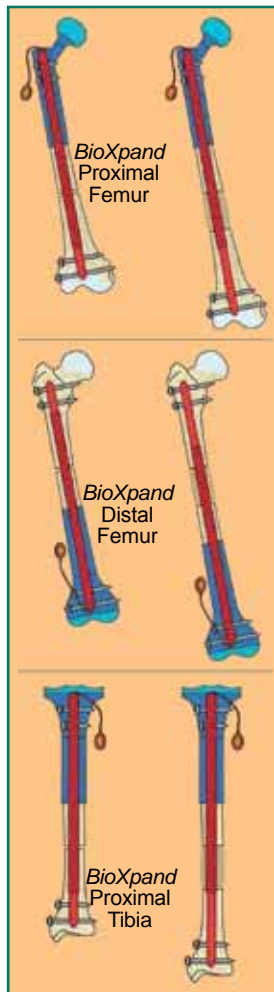
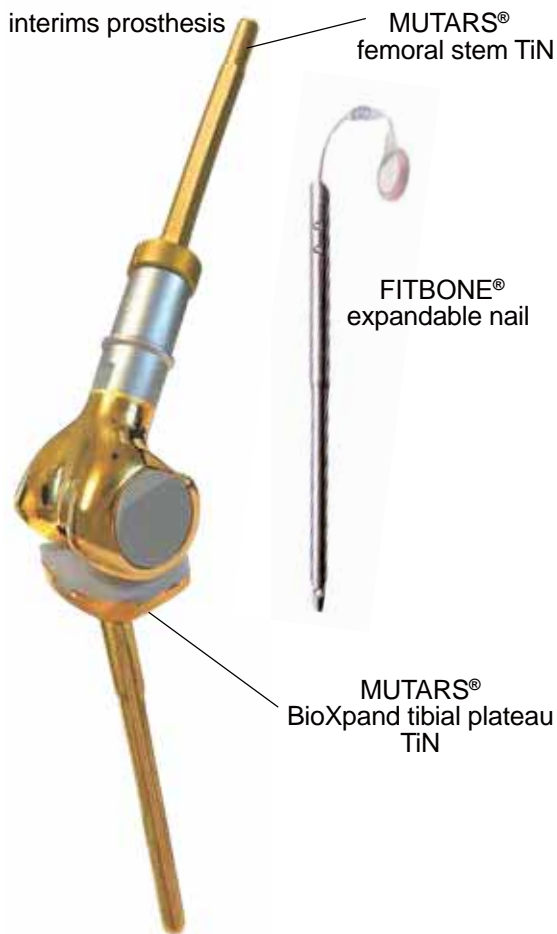

Fig. 1: Principle of the callus-formation with BioXpand



Fig. 2: Steps of callus formation (ZEM-Germany)



Fig. 3: Leg lengthening of 3cm with the BioXpand Prosthesis (ZEM-Germany)

MUTARS® BioXpand Growing Prostheses

In the “biological” MUTARS® BioXpand growing prosthesis, an interim prosthesis is initially implanted. This will later be replaced by a lengthening nail (FITBONE®) at the time when lengthening should be initiated. In this type of growing prosthesis the electromagnetic technology is used to lengthen the bone of the patient and to gain bone stock.

The lengthening of the remaining bone, using the MUTARS® BioXpand Prosthesis

The “biological”, non-invasive BioXpand growing prosthesis for the proximal and distal femur as well as for the proximal tibia simulate bone growth of remaining bone stock post tumour resection. Using the principles of callus distraction (Fig. 1 to 3) the interim prosthesis is replaced by a tumor prosthesis combined with a motorized lengthening nail (FITBONE®), an osteotomy is performed and the remaining bone can be lengthened. After the lengthening procedure the MUTARS® BioXpand components are replaced by conventional MUTARS® components.

NB: All components of the MUTARS® BioXpand Growing Prostheses are customized implants. For the procedure and the lengthening treatment Prof. Dr. R. Baumgart, ZEM-Germany in München should be consulted.

©copyright information: All figures shown on this page are intellectual properties of Prof. Dr. R. Baumgart, ZEM-Germany in München, WITTENSTEIN intens GmbH and implantcast GmbH. The use of these information without prior written permission by the copyright owners is strictly forbidden.

MUTARS® Implants

MUTARS® Implants

*S: Implants are available with Silver coating!

*N: Implants are available with TiN-coating!

*SN: Implants are available with Silver and TiN-coating!

Please notice that the amount of implants and instruments send with an individual shipment may differ from the information in the catalogue information of this brochure. Please make sure, during the preoperatively planning, that all necessary implants and instruments are available for the surgery.



Proximal Femur *S

incl. safety screw

mat.: *implatar*®

5710-0205

50mm

5710-0207

70mm



Proximal Femur Revision *S

incl. safety screw

mat.: TiAlV₄ with EPORE®

5710-0305

50/127°mm

5710-0307

70/127°mm

5710-0405

50/135°mm

5710-0407

70/135°mm



extension piece *S

mat.: *implatar*®

5772-2503S

30mm*

5772-2504

40mm

5772-2506

60mm

5772-2508

80mm

5772-2510

100mm

*only available with silver-coating



connecting part *S

Incl. screw for connecting part

mat.: *implatar*®, UHMW-PE

5730-0100

100mm



reducer *S

mat.: *implatar*®

5730-0220

20mm

5730-0230

30mm



screw, M10

mat.: *implatar*®

5792-1002

25mm

5792-1004

45mm

5792-1005

55mm

5792-1006

65mm

5792-1007

75mm

5792-1008

85mm

5792-1009

95mm

5792-1010

105mm

5792-1011

115mm

5792-1012

125mm

5792-1013

135mm

5792-1014

145mm

5792-1016

165mm

5792-1018

185mm

5792-1020

205mm

5792-1022

225mm

5792-1024

245mm



femoral stem cementless, length 120mm

mat.: *implatar*® with *implaFix*® HA

5760-0111

11mm max. 60 kg

5760-0012

12mm

5760-0113

13mm

5760-0014

14mm

5760-0115

15mm

5760-0016

16mm

5760-0117

17mm

5760-0018

18mm

5760-0019

19mm

5760-0020

20mm



femoral stem cemented *N

mat.: *implavit*®

5760-0011

11 x 120mm max. 75 kg

5760-0013

13 x 120mm

5760-0015

15 x 120mm

5760-0017

17 x 120mm

5760-1116*

11 x 160mm max. 75 kg

5760-1316*

13 x 160mm

5760-1516*

15 x 160mm

5760-1716*

17 x 160mm

5760-1120*

11 x 200mm max. 75 kg

5760-1320*

13 x 200mm

5760-1520*

15 x 200mm

5760-1720*

17 x 200mm

5760-1124*

11 x 240mm max. 75 kg

5760-1324*

13 x 240mm

5760-1524*

15 x 240mm

5760-1724*

17 x 240mm

*with locking holes for Ø 4,5mm screws



femoral stem cemented with HA-collar

mat.: *implavit*® with TiN- and *implaFix*® HA

5769-1211

11 x 120mm max. 75 kg

5769-1213

13 x 120mm

5769-1215

15 x 120mm

5769-1217

17 x 120mm

5769-1611

11 x 160mm max. 75 kg

5769-1613

13 x 160mm

5769-1615

15 x 160mm

5769-1617

17 x 160mm

5769-2011

11 x 200mm max. 75 kg

5769-2013

13 x 200mm

5769-2015

15 x 200mm

5769-2017

17 x 200mm

5769-2411

11 x 240mm max. 75 kg

5769-2413

13 x 240mm

5769-2415

15 x 240mm

5769-2417

17 x 240mm

with locking holes for Ø 4,5mm screws



MUTARS® end piece *S

mat.: *implatar*®

5860-0001



RS proximal component *S

incl. safety screw

mat.: *implatar*®

6710-1527

127° 32mm

6710-1535

135° 32mm

6710-1627

127° 42mm

6710-1635

135° 42mm



RS metaphyseal component

mat.: *implatar*® with *implaFix*® HA

6730-4121

40mm

6730-5121

50mm

6730-4221

40mm small

6730-5221

50mm small



RS Extension piece

mat.: *implatar*®

6730-0125

25mm with *implaFix*® HA

6730-0025

25mm



RS screw, M8

mat.: *implatar*®

6720-4008

40mm

6720-5008

50mm

6720-6508

65mm

6720-7508

75mm

6720-9008

90mm

6720-1008

100mm

6720-1158

115mm

6720-1258

125mm



RS stem** , cementless

mat.: *implatar*® with *implaFix*® HA

6762-1512	12 x 150mm
6762-1513	13 x 150mm
6762-1514	14 x 150mm
6762-1515	15 x 150mm
6762-1516	16 x 150mm
6762-1517	17 x 150mm
6762-1518	18 x 150mm
6762-1519	19 x 150mm
6762-1520	20 x 150mm
6762-1521	21 x 150mm
6762-1522	22 x 150mm
6762-2012	12 x 200mm
6762-2013	13 x 200mm
6762-2014	14 x 200mm
6762-2015**	15 x 200mm
6762-2016**	16 x 200mm
6762-2017**	17 x 200mm
6762-2018**	18 x 200mm
6762-2019**	19 x 200mm
6762-2020**	20 x 200mm
6762-2021**	21 x 200mm
6762-2022**	22 x 200mm
6762-2514	14 x 250mm
6762-2515	15 x 250mm
6762-2516	16 x 250mm
6762-2517**	17 x 250mm
6762-2518**	18 x 250mm
6762-2519**	19 x 250mm
6762-2520**	20 x 250mm
6762-2521**	21 x 250mm
6762-2522**	22 x 250mm

**with locking Holes for Ø 4,5mm screws



RS stem extra slim, cementless

mat.: *implatar*® with *implaFix*® HA

6764-1514HA	14 x 150mm
6764-2014HA	14 x 240mm



RS stem, cemented *N

mat.: *implavit*®

6760-1212	12 x 120mm
6760-1412	14 x 120mm
6760-1612	16 x 120mm
6760-1812	18 x 120mm
6760-1215	12 x 150mm
6760-1415	14 x 150mm
6760-1615	16 x 150mm
6760-1815	18 x 150mm
6761-1220	12 x 200mm
6761-1420	14 x 200mm
6761-1620	16 x 200mm
6761-1820	18 x 200mm



screw for RS adapter, M8

mat.: *implatar*®

5792-0060	60mm
5792-0080	80mm
5792-0100	100mm
5792-0120	120mm
5792-0140	140mm



RS coupling device 30mm *S

mat.: *implatar*®

5772-0030

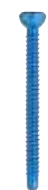

cortical screw Ø 4,5mm

mat.: *implatar*®

5792-4525	25mm
5792-4530	30mm
5792-4540	40mm
5792-4542	42mm
5792-4545	45mm
5792-4550	50mm
5792-4555	55mm
5792-4560	60mm



ic-bipolar head CoCrMo

mat.: *implavit*® and UHMW-PE

2151-0044	28/44mm
2151-0046	28/46mm
2151-0048	28/48mm
2151-0050	28/50mm
2151-0052	28/52mm
2151-0054	28/54mm
2151-0056	28/56mm
2151-0058	28/58mm
2151-0060	28/60mm



ic-head CoCrMo

cone 12/14mm

mat.: *implavit*®

2312-2200	22mm, K
2312-2205	22mm, M
2312-2210	22mm, L
2387-2800	28mm, K
2387-2805	28mm, M
2387-2810	28mm, L
2387-2815	28mm, XL
2387-3200	32mm, K
2387-3205	32mm, M
2387-3210	32mm, L
2387-3215	32mm, XL
2387-3600	36mm, K
2387-3605	36mm, M
2387-3610	36mm, L
2387-3615	36mm, XL



ic-head CoCrMo TiN

cone 12/14mm

mat.: *implavit*® with TiN-coating

2322-2200	22mm, S
2322-2205	22mm, M
2322-2210	22mm, L



ic-head titanium

cone 12/14mm

mat.: *implatar*® with TiN-coating

2787-2800	28mm, K
2787-2805	28mm, M
2787-2810	28mm, L
2787-2815	28mm, XL
2787-3200	32mm, K
2787-3205	32mm, M
2787-3210	32mm, L
2787-3215	32mm, XL
2787-3600	36mm, K
2787-3605	36mm, M
2787-3610	36mm, L
2787-3615	36mm, XL



ic-head Biolox® delta

cone 12/14mm

mat.: Al₂O₃ and ZrO₂

2586-2800	28mm, K
2586-2805	28mm, M
2586-2810	28mm, L
2586-3200	32mm, K
2586-3205	32mm, M
2586-3210	32mm, L
2586-3215	32mm, XL
2586-3600	36mm, K
2586-3605	36mm, M
2586-3610	36mm, L
2586-3615	36mm, XL



ic-head revision Biolox® delta

mat.: Al₂O₃ und ZrO₂

2589-2800	28mm
2589-3200	32mm
2589-3600	36mm
2589-4000	40mm
2589-4400	44mm



taper adapter for ic-head revision Biolox® delta

mat.: *implatar*®

2588-0000	S
2588-0005	M
2588-0010	L
2588-0015	XL

MUTARS® Implants



EcoFit® 2M Cup, cementless

mat.: *implavit®* with *implaFix® Duo*

0220-1042	Ø 38/42mm
0220-1044	Ø 40/44mm
0220-1046	Ø 42/46mm
0220-1048	Ø 44/48mm
0220-1050	Ø 46/50mm
0220-1052	Ø 48/52mm
0220-1054	Ø 50/54mm
0220-1056	Ø 52/56mm
0220-1058	Ø 54/58mm
0220-1060	Ø 56/60mm
0220-1062	Ø 58/62mm
0220-1064	Ø 58/64mm



EcoFit® 2M cup, cemented

mat.: *implavit®*

0220-1144	Ø 38/44mm
0220-1146	Ø 40/46mm
0220-1148	Ø 42/48mm
0220-1150	Ø 44/50mm
0220-1152	Ø 46/52mm
0220-1154	Ø 48/54mm
0220-1156	Ø 50/56mm
0220-1158	Ø 52/58mm
0220-1160	Ø 54/60mm
0220-1162	Ø 56/62mm
0220-1164	Ø 58/64mm

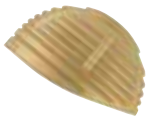

EcoFit® 2M cup, cemented

mat.: *implavit®* with *TiN-coating*

0220-1144N	Ø 38/44mm
0220-1146N	Ø 40/46mm
0220-1148N	Ø 42/48mm
0220-1150N	Ø 44/50mm
0220-1152N	Ø 46/52mm
0220-1154N	Ø 48/54mm
0220-1156N	Ø 50/56mm
0220-1158N	Ø 52/58mm
0220-1160N	Ø 54/60mm
0220-1162N	Ø 56/62mm
0220-1164N	Ø 58/64mm



2M implacross® E head

mat.: *implacross® E*

2905-2238	Ø 22/38mm
2905-2240	Ø 22/40mm
2905-2842	Ø 28/42mm
2905-2844	Ø 28/44mm
2905-2846	Ø 28/46mm
2905-3248	Ø 32/48mm
2905-3250	Ø 32/50mm
2905-3252	Ø 32/52mm
2905-3254	Ø 32/54mm
2905-3256	Ø 32/56mm
2905-3258	Ø 32/58mm



MUTARS® RS cup

incl. central plug M16 x 1
mat.: *TiAl V₄* with *EPORE®*

5712-0546	Ø 46mm left
5712-0550	Ø 50mm left
5712-0554	Ø 54mm left
5712-0558	Ø 58mm left
5712-0562	Ø 62mm left
5712-0046	Ø 46mm right
5712-0050	Ø 50mm right
5712-0054	Ø 54mm right
5712-0058	Ø 58mm right
5712-0062	Ø 62mm right



Fastening bolt for MUTARS® RS cup

Mat.: *implatar®*
5712-0000



LUMiC® cup

incl. safety screw
mat.: *implatar®*

5711-0050	50mm
5711-0054	54mm
5711-0160	60mm
5711-0060S	60mm silver
5711-0250	50mm HA
5711-0254	54mm HA
5711-0260	60mm HA



fastening bolt for MUTARS® LUMiC® cup

mat.: *implatar®*
5711-1003



LUMiC® stem, cementless

mat.: *implatar®* with *implaFix® HA*

5711-1865	8 x 65mm
5711-1875	8 x 75mm
5711-1885	8 x 85mm
5711-1065	10 x 65mm
5711-1075	10 x 75mm
5711-1085	10 x 85mm



LUMiC® stem, cemented

mat.: *implavit®*

5711-2865	8 x 65mm
5711-2875	8 x 75mm
5711-2885	8 x 85mm



LUMiC® screw, M6

mat.: *implavit®*
5711-1002 28mm



2M inlay 15° for MUTARS® RS Cup and LUMiC® TiN

mat.: *implavit®* with *TiN-coating, UHMW-PE*

0242-3839	Ø 38/39mm
0242-4244	Ø 42/44mm
0242-4448	Ø 44/48mm
0242-4652	Ø 46/52mm



implacross® PE-inlay 15° neutral 0mm

mat.: *implacross®*

0227-3239	Ø 32/39mm
0227-3644	Ø 36/44mm
0227-3648	Ø 36/48mm
0227-3652	Ø 36/52mm



implacross® PE-inlay 15° offset 4mm

mat.: *implacross®*

0228-3239	Ø 32/39mm
0228-3644	Ø 36/44mm
0228-3648	Ø 36/48mm
0228-3652	Ø 36/52mm

MUTARS® Implants



Distal Femur M-O-M *S *N *SN

incl. safety screw

mat.: *implavit*®

5720-0035*	110mm left extra small
5720-0030*	110mm right extra small
5720-0037*	90mm left extra small
5720-0032*	90mm right extra small
5720-0045	110mm left
5720-0040	110mm right
5720-0047	90mm left
5720-0042	90mm right

*size xsmall available on special request



KRI M-O-M *N *SN

incl. safety screw

mat.: *implavit*®

5720-0043	left
5720-0048	right



screw for KRI, M8

mat.: *implatan*®

5720-2508	25mm
5720-5008	50mm



GenuX® MK femoral component cemented *N

mat.: *implavit*

5720-0505	left	size 2
5720-0500	right	size 2
5720-0515	left	size 3
5720-0510	right	size 3
5720-0525	left	size 4
5720-0520	right	size 4
5720-0535	left	size 5
5720-0530	right	size 5
5720-0545*	left	size 6
5720-0540*	right	size 6

*size 6 available in Q1 2020



GenuX® MK femoral component cementless *N

mat.: *implavit*®

5720-1405	left	size 2
5720-1400	right	size 2
5720-1415	left	size 3
5720-1410	right	size 3
5720-1425	left	size 4
5720-1420	right	size 4
5720-1435	left	size 5
5720-1430	right	size 5
5720-1445*	left	size 6
5720-1440*	right	size 6

*size 6 available in Q1 2020



MUTARS® GenuX® MK femoral component Monoblock, cemented

mat.: *implavit*®

5720-0402	left	2/10mm
5720-0412	right	2/10mm
5720-0415	left	3/11mm
5720-0410	right	3/11mm
5720-0425	left	4/12mm
5720-0420	right	4/12mm
5720-0435	left	5/13mm
5720-0430	right	5/13mm



MK Femoral spacer distal

incl. MK screw for spacer

mat.: *implatan*®

5722-5205	l/rm	size 2	5mm
5722-5200	l/rm	size 2	10mm
5722-0205	r/lm	size 2	5mm
5722-0200	r/lm	size 2	10mm
5722-5305	l/rm	size 3	5mm
5722-5300	l/rm	size 3	10mm
5722-0305	r/lm	size 3	5mm
5722-0300	r/lm	size 3	10mm
5722-5405	l/rm	size 4	5mm
5722-5400	l/rm	size 4	10mm
5722-0405	r/lm	size 4	5mm
5722-0400	r/lm	size 4	10mm
5722-5505	l/rm	size 5	5mm
5722-5500	l/rm	size 5	10mm
5722-0505	r/lm	size 5	5mm
5722-0500	r/lm	size 5	10mm
5722-5605*	l/rm	size 6	5mm
5722-5600*	l/rm	size 6	10mm
5722-0605*	r/lm	size 6	5mm
5722-0600*	r/lm	size 6	10mm

*size 6 available in Q1 2020



MK femoral spacer posterior

incl. MK screw for spacer

mat.: *implatan*®

5722-2005	size 2	5mm
5722-2010	size 2	10mm
5722-3005	size 3	5mm
5722-3010	size 3	10mm
5722-4005	size 4	5mm
5722-4010	size 4	10mm
5722-5005	size 5	5mm
5722-5010	size 5	10mm
5722-6005*	size 6	5mm
5722-6010*	size 6	10mm

*size 6 available in Q1 2020



MK screw for spacer

mat.: *implatan*®

5720-1216



MUTARS® coupling 12,5mm *N

mat.: *implavit*®

5720-1210



GenuX® MK MB PE insert

mat.: *UHMW-PE*

5721-0102	size 2
5721-0103	size 3
5721-0104	size 4
5721-0105	size 5
5721-0106*	size 6

*size 6 available in Q1 2020



GenuX® MK FB PE insert

mat.: *UHMW-PE*

5721-0202	size 2
5721-0203	size 3
5721-0204	size 4
5721-0205	size 5
5721-0206*	size 6

*size 6 available in Q1 2020



GenuX® MK offset adapter

mat.: *implatan*®

5751-0000	0mm
5751-0002	2mm
5751-0004	4mm
5751-0006	6mm



patella replacement, cemented

mat.: *UHMW-PE*

5720-1000	standard
5720-1001	large

MUTARS® Implants



GenuX® MK tibial component cemented *N
incl. safety screw + screw for coupling
mat.: *implavit*®

5751-0602	size 2
5751-0603	size 3
5751-0604	size 4
5751-0605	size 5
5751-0606*	size 6

*size 6 available in Q1 2020

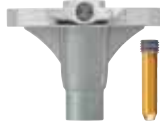

GenuX® MK tibial component cementless *N
incl. safety screw + screw for coupling
mat.: *implavit*®

5751-0702	size 2
5751-0703	size 3
5751-0704	size 4
5751-0705	size 5
5751-0706*	size 6

*size 6 available in Q1 2020



MUTARS® GenuX® MK tibial component Monoblock cemented
incl. safety screw + locking screw
mat.: *implavit*

5751-0402	2/10mm
5751-0400	3/11mm
5751-0405	4/12mm
5751-0410	5/13mm



MK tibial spacer *S
incl. MK screw
mat.: *implatan*®

5740-5052	l/rm	size 2	5mm
5740-5053	l/rm	size 3	5mm
5740-5054	l/rm	size 4	5mm
5740-5055	l/rm	size 5	5mm
5740-5056*	l/rm	size 6	5mm
5741-0052	r/lm	size 2	5mm
5741-0053	r/lm	size 3	5mm
5741-0054	r/lm	size 4	5mm
5741-0055	r/lm	size 5	5mm
5741-0056*	r/lm	size 6	5mm
5740-5102	l/rm	size 2	10mm
5740-5103	l/rm	size 3	10mm
5740-5104	l/rm	size 4	10mm
5740-5105	l/rm	size 5	10mm
5740-5106*	l/rm	size 6	10mm
5741-0102	r/lm	size 2	10mm
5741-0103	r/lm	size 3	10mm
5741-0104	r/lm	size 4	10mm
5741-0105	r/lm	size 5	10mm
5741-0106*	r/lm	size 6	10mm
5740-5152	l/rm	size 2	15mm
5740-5153	l/rm	size 3	15mm
5740-5154	l/rm	size 4	15mm
5740-5155	l/rm	size 5	15mm
5740-5156*	l/rm	size 6	15mm
5741-0152	r/lm	size 2	15mm
5741-0153	r/lm	size 3	15mm
5741-0154	r/lm	size 4	15mm
5741-0155	r/lm	size 5	15mm
5741-0156*	r/lm	size 6	15mm
5740-5202	l/rm	size 2	20mm
5740-5203	l/rm	size 3	20mm
5740-5204	l/rm	size 4	20mm
5740-5205	l/rm	size 5	20mm
5740-5206*	l/rm	size 6	20mm
5741-0202	r/lm	size 2	20mm
5741-0203	r/lm	size 3	20mm
5741-0204	r/lm	size 4	20mm
5741-0205	r/lm	size 5	20mm
5741-0206*	r/lm	size 6	20mm

*size 6 available in Q1 2020



MK tibial spacer *S
incl. MK screw
mat.: *implatan*®

5740-0252	size 2	25mm
5740-0352	size 2	35mm
5740-0452	size 2	45mm
5740-0253	size 3	25mm
5740-0353	size 3	35mm
5740-0453	size 3	45mm
5740-0254	size 4	25mm
5740-0354	size 4	35mm
5740-0454	size 4	45mm
5740-0255	size 5	25mm
5740-0355	size 5	35mm
5740-0455	size 5	45mm
5740-0256*	size 6	25mm
5740-0356*	size 6	35mm
5740-0456*	size 6	45mm

*size 6 available in Q1 2020



MK Proximal Tibia *S
Incl. screw for connecting part
mat.: *implatan*® with TiN-coating, UHMW-PE
5750-0005



connecting part for Proximal Tibia *S
mat.: *implatan*®

5750-0105	105mm
5750-0125	125mm



tibial stem cementless, length 120mm
mat.: *implatan*® with *implaFix*® HA

5750-1511	11mm max. 60kg
5750-1512	12mm
5750-1513	13mm
5750-1514	14mm
5750-1515	15mm
5750-1516	16mm



tibial stem cemented *N, length 120mm
mat.: *implavit*®

5750-0511	11mm max. 75kg
5750-0513	13mm
5750-0515	15mm



tibial stem cemented TiN-coating and HA-collar
mat.: *implavit*® with TiN-coating and *implaFix*® HA

5759-1211	11 max. 75kg
5759-1213	13
5759-1215	15

with locking holes for Ø 4,5mm screws



tapered stem, cementless, length 130mm
mat.: *implatan*®

5760-2014	14mm
5760-2015	15mm
5760-2016	16mm
5760-2017	17mm
5760-2018	18mm
5760-2019	19mm
5760-2020	20mm
5760-2021	21mm
5760-2022	22mm
5760-2023	23mm



GenuX® MK stem cementless HA

mat.: *implatar®* with *implaFix®* HA

5767-1212	12 x 125mm
5767-1412	14 x 125mm
5767-1612	16 x 125mm
5767-1812	18 x 125mm
5767-2012	20 x 125mm
5767-2212	22 x 125mm
5767-2412	24 x 125mm
5767-2612	26 x 125mm
5767-2812	28 x 125mm
5767-1215	12 x 150mm
5767-1415	14 x 150mm
5767-1615	16 x 150mm
5767-1815	18 x 150mm
5767-2015	20 x 150mm
5767-2215	22 x 150mm
5767-1220*	12 x 200mm
5767-1420*	14 x 200mm
5767-1620*	16 x 200mm
5767-1820*	18 x 200mm
5767-2020*	20 x 200mm
5767-2220*	22 x 200mm
5767-1225*	12 x 250mm
5767-1425*	14 x 250mm
5767-1625*	16 x 250mm
5767-1825*	18 x 250mm
5767-2025*	20 x 250mm
5767-2225*	22 x 250mm

*with locking holes for Ø 4,5mm screws



GenuX® MK stem cemented *N

mat.: *implavi®*

5766-1112	11 x 125mm
5766-1312	13 x 125mm
5766-1512	15 x 125mm
5766-1712	17 x 125mm
5766-1912	19 x 125mm
5766-1115	11 x 150mm
5766-1315	13 x 150mm
5766-1515	15 x 150mm
5766-1715	17 x 150mm
5766-1915	19 x 150mm
5766-1120*	11 x 200mm
5766-1320*	13 x 200mm
5766-1520*	15 x 200mm
5766-1720*	17 x 200mm
5766-1920*	19 x 200mm
5766-1125*	11 x 250mm
5766-1325*	13 x 250mm
5766-1525*	15 x 250mm
5766-1725*	17 x 250mm
5766-1925*	19 x 250mm

*with locking holes for Ø 4,5mm screws



Diaphyseal Implant *S *N, stem length 100mm

incl. screws for connecting part

mat.: *implavi®*, UHMW-PE

5730-1013	13mm
5730-1015*	15mm
5730-1017*	17mm
5730-1019*	19mm

*with locking holes for Ø 4,5mm screws



connecting part for Diaphyseal Implant *S

mat.: *implatar®*

5730-1100	100mm
5730-1120	120mm



Arthrodesis *S

incl. screws

mat.: *implatar®*, UHMW-PE

5730-0162



tibial plate *N

mat.: *implavi®*

5730-0164



RS Arthrodesis femoral component *S

incl. safety screw

mat.: *implatar®*

6770-0011	left
6770-0021	right



RS Arthrodesis tibial component *S

incl. safety screw and screw with safety pin

mat.: *implatar®*, UHMW-PE

6770-0031



intramedullary connecting Module *S for KRI, cementless Ø 15mm

mat.: *implatar®*

5720-5100	100mm
5720-5120	120mm
5720-5140	140mm
5720-5160	160mm
5720-5180	180mm
5720-5200	200mm
5720-5220	220mm
5720-5240	240mm
5720-5260	260mm
5720-5280	280mm
5720-5300	300mm
5720-5320	320mm
5720-5340	340mm
5720-5360	360mm



intramedullary connecting Module *S for GenuX® MK, cementless Ø 15mm

mat.: *implatar®*

5721-6100	100mm
5721-6120	120mm
5721-6140	140mm
5721-6160	160mm
5721-6180	180mm
5721-6200	200mm
5721-6220	220mm
5721-6240	240mm
5721-6260	260mm
5721-6280	280mm
5721-6300	300mm
5721-6320	320mm
5721-6340	340mm
5721-6360	360mm
5721-6380	380mm
5721-6400	400mm
5721-6420	420mm
5721-6440	440mm



intramedullary plug

mat.: UHMW-PE

0299-4000	small medullary cavity ≥ Ø: 9mm
0299-4010	large medullary cavity ≥ Ø: 14mm



ic- cerclage titanium 2R

mat.: pure titanium (cpTi)

0060-1018



attachment tube, length 300mm

mat.: Polyethylenterephthalat (PET)

5900-0300	Ø: 35mm
5900-0310	Ø: 55mm

MUTARS® Implants



Humerus cap
mat.: implatan® with TiN-coating
 5210-0000 small
 5210-0005 medium
 5210-0010 large



Humerus inverse cap
mat.: implatan® with TiN-coating
 5210-1000
 5210-1005 + 5mm
 5210-1010 + 10mm



Humerus head 50mm *S
 incl. safety screw
mat.: implatan®
 5200-0000



Humerus extension piece *S
mat.: implatan®
 5220-0020 20mm
 5220-0040 40mm
 5220-0060 60mm



Humerus connecting part *S
 incl. screws for connecting part
mat.: implatan®
 5221-0080 80mm



Humerus reducer *S
mat.: implatan®
 5221-0000 10mm
 5221-0100 100mm



Humeral screw, M8
mat.: implatan®
 5230-0015 15mm
 5230-0035 35mm
 5230-0055 55mm
 5230-0075 75mm



Humeral stem, cementless, length 75mm
mat.: implatan® with implaFix® HA
 5240-0807 7mm
 5240-0808 8mm
 5240-0809* 9mm
 5240-0810* 10mm
 5240-0811* 11mm
 5240-0812* 12mm
 5240-0813* 13mm
 5240-0814* 14mm
 5240-0815* 15mm
 5240-0816* 16mm
 *with locking holes for Ø 3.5mm screws



Humeral stem, cemented *N, length 75mm
mat.: implavit®
 5240-0408 8mm
 5240-0409 9mm
 5240-0410 10mm
 5240-0411 11mm
 5240-0412 12mm



Humeral stem, cemented with TiN-coating and HA-collar, length 75mm
mat.: implavit® with TiN-coating and implaFix® HA
 5249-0408 8mm
 5249-0409 9mm
 5249-0410 10mm
 5249-0411 11mm
 5249-0412 12mm



Humerus end piece
mat.: implatan®
 5220-0001



Humerus Diaphyseal Implant, cemented *S
 length 80mm
 incl. connecting part
mat.: implatan®
 5731-1008 8mm
 5731-1009 9mm
 with locking holes for Ø 3.5mm screws



Distal Humerus 50mm *S *N
 incl. axle, safety screw and 2 lock screws
mat.: implatan® and implavit®
 5250-0000



Distal Humerus 30mm
 incl. axle, safety screw and 2 cover screws
mat.: implatan® and implavit®
 5250-2300



screw for Distal Humerus 30mm, M6
mat.: implatan®
 5230-0125 12,5mm SW5
 5230-0200 20mm SW5
 5230-0225 22,5mm SW5
 5230-0250 25mm SW5
 5230-0275 27,5mm SW5
 5230-0300 30mm SW5



Proximal Ulna *S
 incl. safety screw
mat.: implatan® and implavit®
 5250-0030



ulna anchorage, cementless
mat.: implatan® and implavit® with implaFix® Duo
 5250-1015 left
 5250-1020 right



ulnar component, cemented *N
mat.: implavit®
 5250-5070 left 70mm
 5250-0070 right 70mm
 5250-5100 left 100mm
 5250-0100 right 100mm



ulna stop
mat.: UHMW-PE
 5250-1100



AGILON® stem, cementless
mat.: implatan®
 3850-6009 9 x 60mm
 3850-6010 10 x 60mm
 3850-6011 11 x 60mm
 3850-6012 12 x 60mm
 3850-6013 13 x 60mm
 3850-6014 14 x 60mm
 3850-6015 15 x 60mm
 3850-6016 16 x 60mm
 3850-6017 17 x 60mm
 3850-6018 18 x 60mm
 3851-2009 9 x 120mm
 3851-2010 10 x 120mm
 3851-2011 11 x 120mm
 3851-2012 12 x 120mm
 3851-2013 13 x 120mm
 3851-2014 14 x 120mm
 3851-2015 15 x 120mm
 3851-2016 16 x 120mm
 *stems in lengths of 30mm, 180mm and 240mm available on special request



AGILON® stem, cemented *N
mat.: implavit®
 3840-6006 6 x 60mm
 3840-6008 8 x 60mm
 3840-6010 10 x 60mm
 3840-6012 12 x 60mm
 3840-9006 6 x 90mm
 3840-9008 8 x 90mm
 3840-9010 10 x 90mm
 3840-9012 12 x 90mm
 3841-2006 6 x 120mm
 3841-2008 8 x 120mm
 3841-2010 10 x 120mm
 3841-2012 12 x 120mm

MUTARS® Implants



AGILON® extension piece

mat.: implatan®

3821-0075	7.5mm
3821-0100	10mm
3821-0125	12.5mm
3821-0150	15mm
3821-0175	17.5mm



cancellous screw, angle stable locked Ø 4,2mm

mat.: implatan®

5794-4220	20mm
5794-4222	22mm
5794-4224	24mm
5794-4226	26mm
5794-4228	28mm
5794-4230	30mm
5794-4232	32mm
5794-4234	34mm
5794-4236	36mm
5794-4238	38mm
5794-4240	40mm



spongiosa screw flat head Ø 6,5mm

mat.: implatan®

0280-1015	15mm
0280-1020	20mm
0280-1025	25mm
0280-1030	30mm
0280-1035	35mm
0280-1040	40mm
0280-1045	45mm
0280-1050	50mm
0280-1055	55mm
0280-1060	60mm
0280-1065	65mm
0280-1070	70mm



glenoid

mat.: pure titanium (cpTi) with implaFix® HA
3800-4001 size 3 round



AGILON® glenoid anatomical

mat.: pure titanium (cpTi) with implaFix® HA
3800-4028 size 2 short
3800-4029 size 2 long
3800-4009 size 3 short
3800-4010 size 3 long



AGILON® glenoid PE-insert anatomical

mat.: UHMW-PE

3803-1028	size 2
3803-1032	size 3
3803-1036	size 4



AGILON® glenosphere

mat.: UHMW-PE

3803-2840	size 2	40mm eccentric
3803-3240	size 3	40mm eccentric
5210-1002	size 3	40mm symmetric

(MUTARS® glenosphere)



AGILON® glenoid cemented

mat.: UHMW-PE

3803-0032	size 2
3803-0036	size 3
3803-0040	size 4

material and coating catalogue

materials:

Al ₂ O ₃ and ZrO ₂	acc. to ISO 6474-2
implacross®; crosslinked UHMW-PE	
implacross E®; crosslinked UHMW-PE with vitamin E	
implatan®; TiAl ₆ V ₄	acc. to ISO 5832-3
implavit®; CoCrMo	acc. to ISO 5832-4
implavit®; CoCrMo	acc. to ISO 5832-12
Polyethylenterephthalat (PET)	
pure titanium (cpTi)	acc. to ISO 5832-2
TiAl ₆ V ₄ mit EPORE®	
UHMW-PE	acc. to ISO 5834-2

coatings:

implaFix®; cpTi-coating	
implaFix®; cpTi-coating and TCP-coating	
implaFix® Duo; implaFix® and implaFix® HA	
implaFix® HA; HA-coating	acc. to ISO 13779-2
silver-coating	
TiN-coating (titanium nitride coating)	

MUTARS® Instruments

MUTARS® Instruments

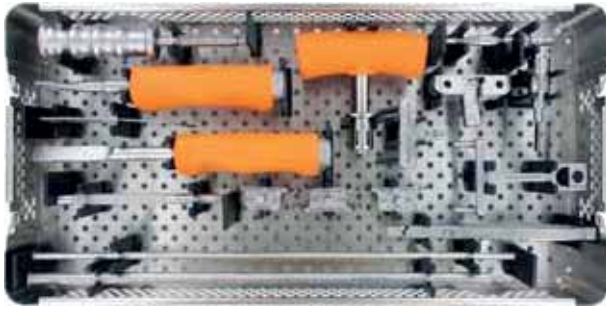

MK basic container
7999-5800

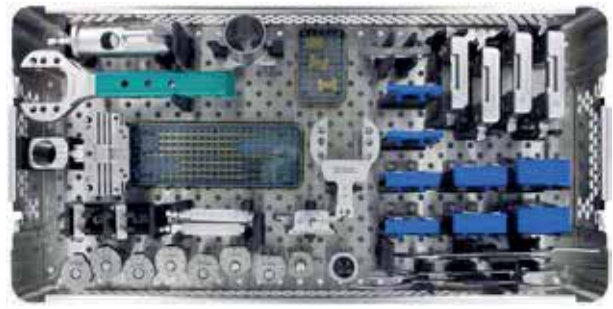

MK femoral container
7999-5801

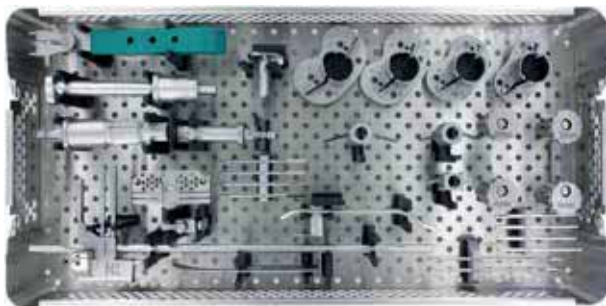

MK tibial container
7999-5812

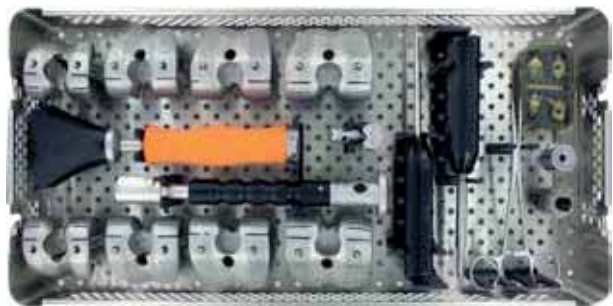

MK femoral trial container
7999-5803

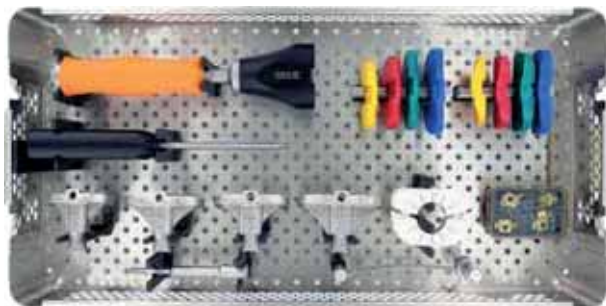

MK tibial trial container
7999-5804



MK trial stem container
7999-5805

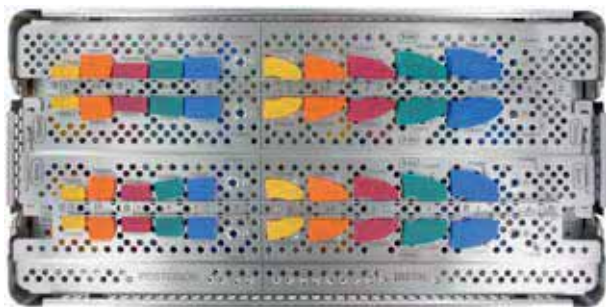

MK spacer container upper tray
7999-5806



MK spacer container middle tray
7999-5806



**MK spacer container
bottom tray**
7999-5806

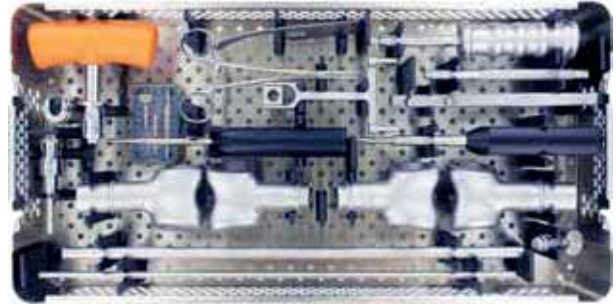

**MUTARS® distal femoral MK basic
container**
7999-5821

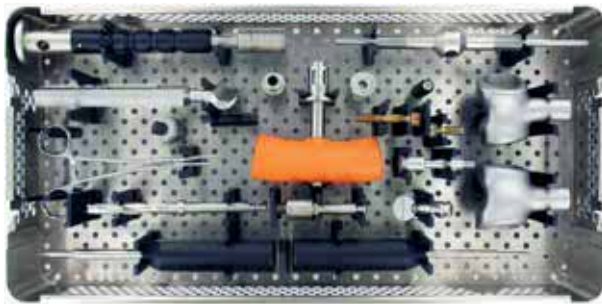

**MUTARS® KRI MK
container**
7999-5829

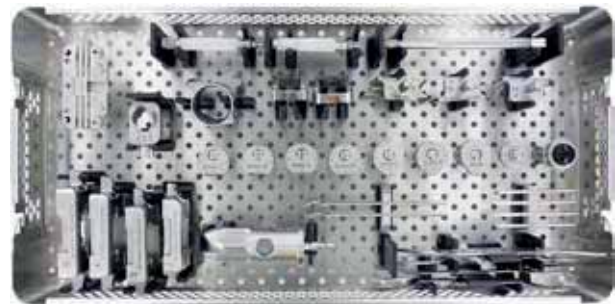

**MUTARS® proximal tibia MK femoral
container**
7999-5833

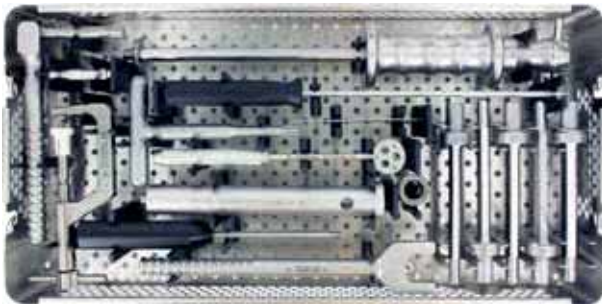

**MUTARS® proximal tibia MK basic
container**
7999-5834



**MUTARS® proximal tibia MK drill
container**
7999-5835

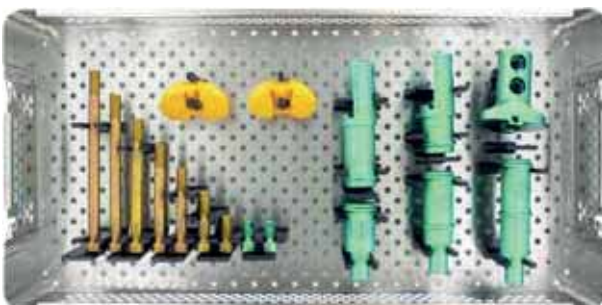

**MUTARS® proximal tibia MK trial
container**
7999-5836



**MUTARS® proximal tibia MK trial stem
container**
7999-5837

MUTARS® Instruments

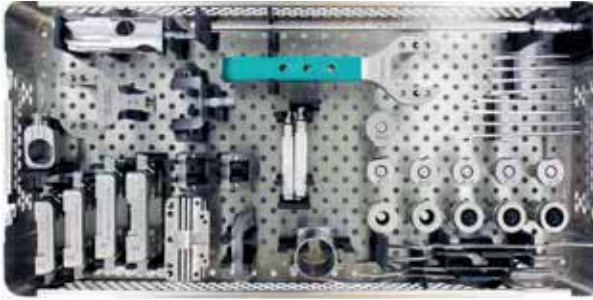

GenuX® MK monoblock femoral container
7999-5840

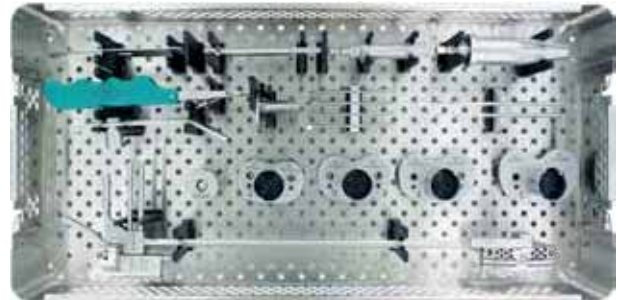

GenuX® MK monoblock tibial container
7999-5841

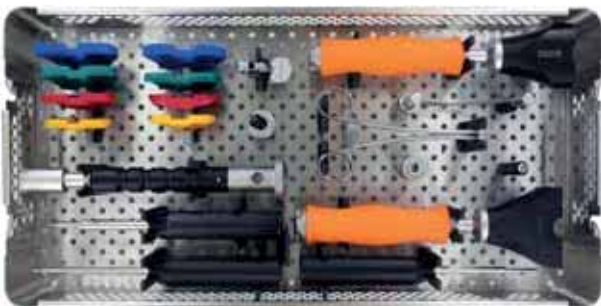

GenuX® MK monoblock trial container 1
7999-5842



GenuX® MK monoblock trial container 2
7999-5843

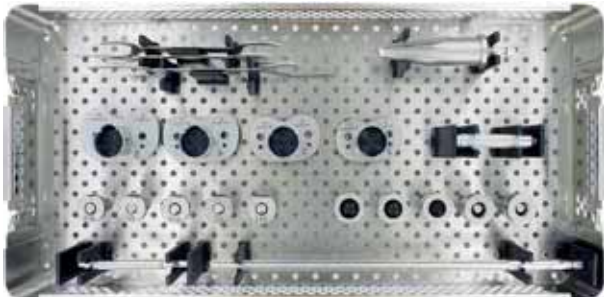

GenuX® MK monoblock extension container
7999-5844

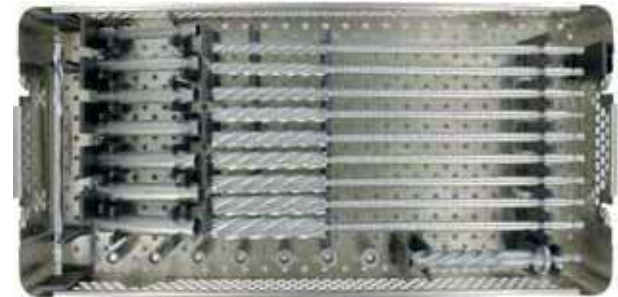

Rigid drill container 1
7999-5774

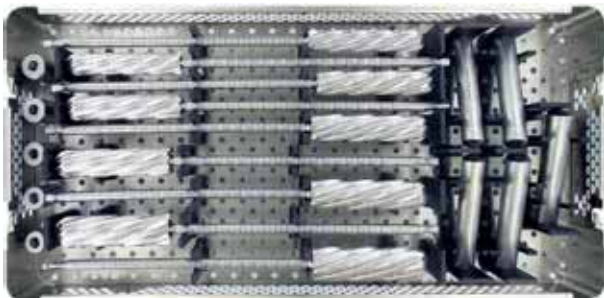

Rigid drill container 2
7999-5775

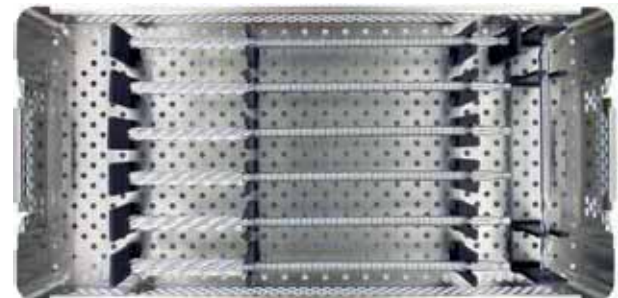

Rigid drill container 3
7999-5776

MUTARS® Instruments

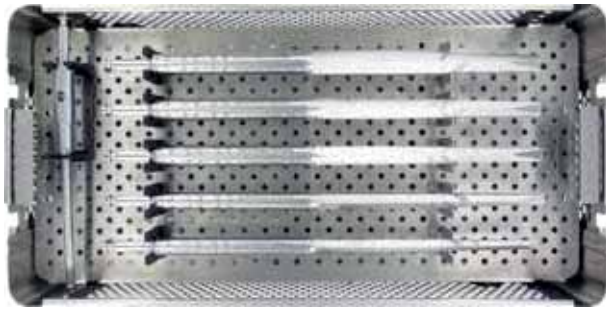

**MUTARS® RS broach container
upper tray**
7999-6721

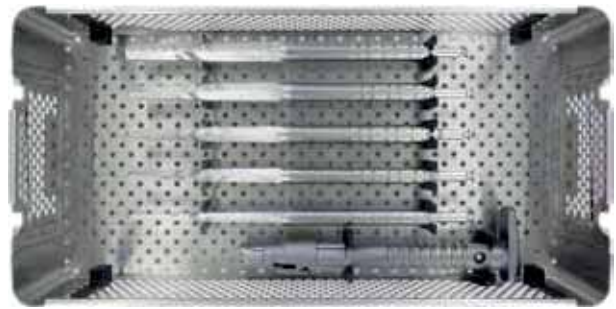

**MUTARS® RS broach container
lower tray**
7999-6721

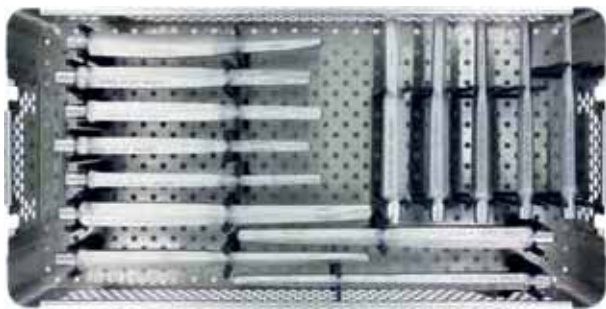

**MUTARS® RS trial stem
container**
7999-6724

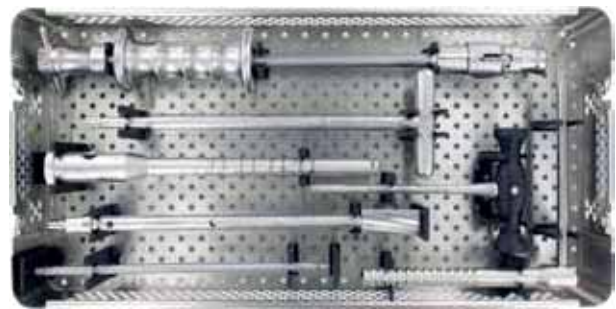

**MUTARS® RS ES
container 2**
7999-6715

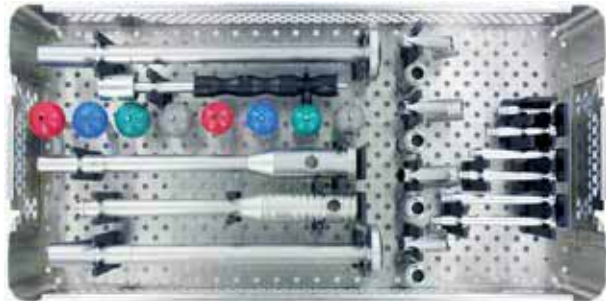

**MUTARS® RS ES
container 3**
7999-6716

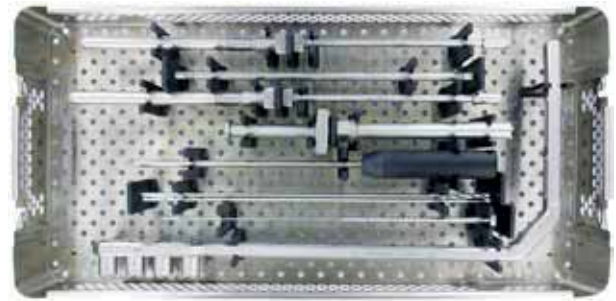

**MUTARS® RS
container 5**
7999-6705



**stem assembling
container**
7999-5770



**Flexible drill Nitinol
container**
7999-7000

MUTARS® Instruments

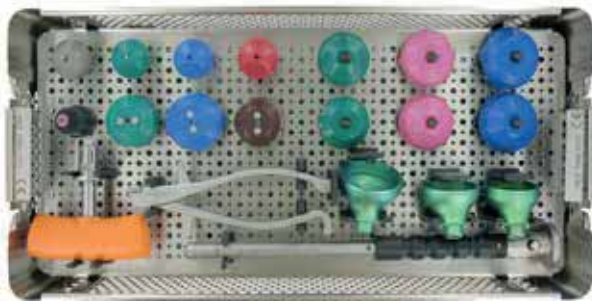

MUTARS® LUMiC® container 1
upper tray
7999-5701

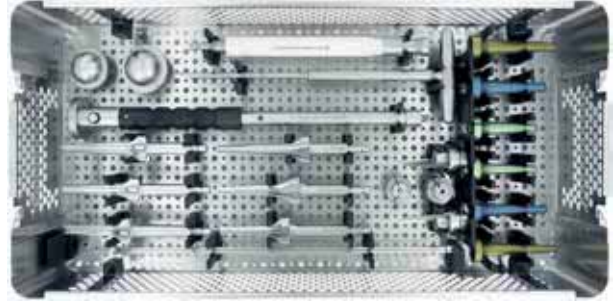

MUTARS® LUMiC® container 1
lower tray
7999-5701



MUTARS® 2M trial LUMiC® container
7999-5704



trial insert 15° container for LUMiC
2950-1068

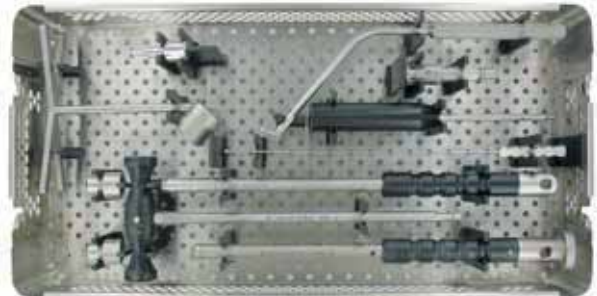

MUTARS® LUMiC® container 2
7999-5702

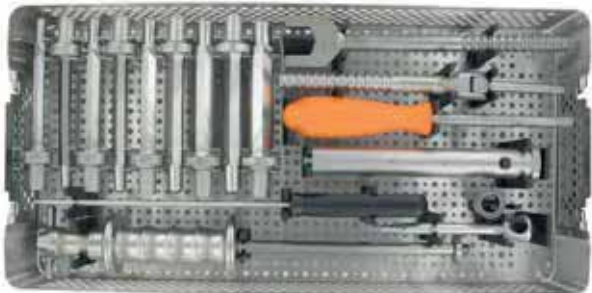

MUTARS® basic container
7999-5712

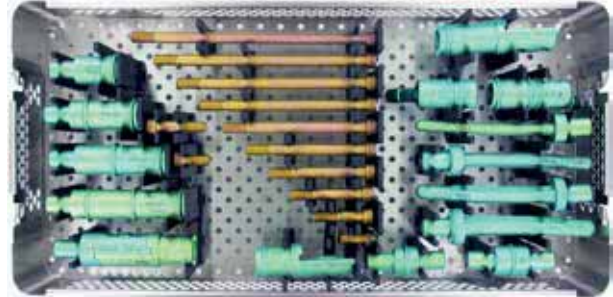

MUTARS® trial container
7999-7701

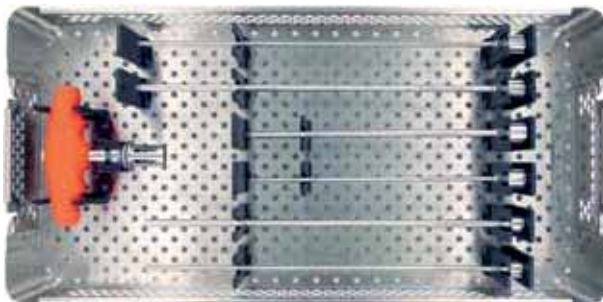

MUTARS® biopsy punch container
7999-7211

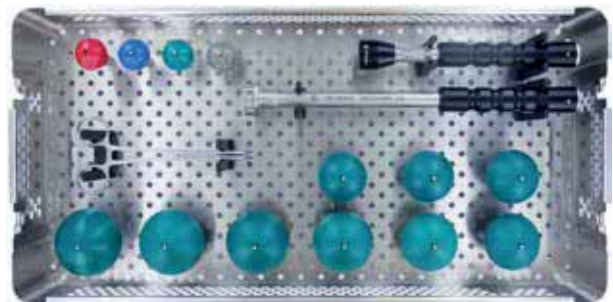

ic-bipolar container
7960-9999

MUTARS® Instruments

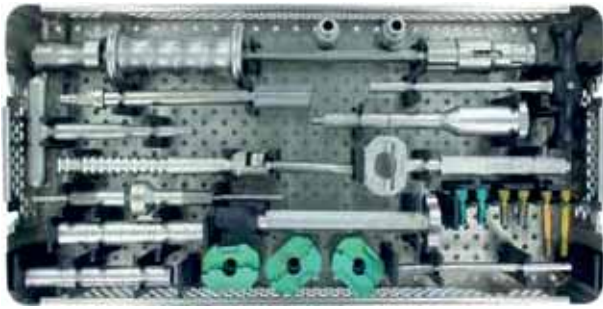

MUTARS® RS arthrodesis container
7999-6770



MUTARS® patella container
7999-5745



MUTARS® IMFR KRI trial container upper tray
7999-7720



MUTARS® IMFR KRI trial container lower tray
7999-7720



MUTARS® humerus container
7999-5200

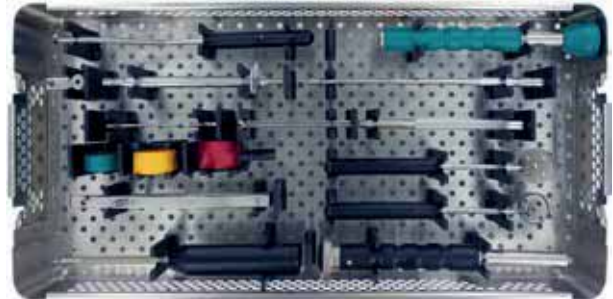

MUTARS® humerus inverse container
7999-5201



MUTARS® humerus trial container
7999-5202



MUTARS® prox. ulna container
7999-5205



MUTARS® distal humerus container
7999-5150

MUTARS® Instruments

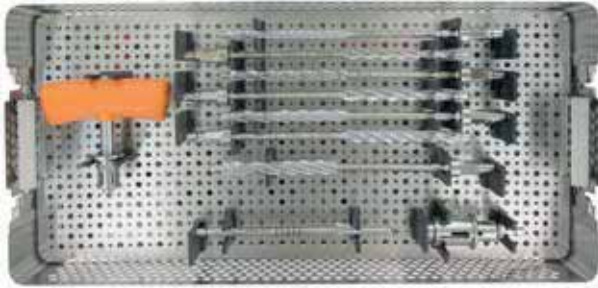

MUTARS® distal humerus 30mm for M6 long fit container upper tray
7999-5203



MUTARS® distal humerus 30mm for M6 long fit container lower tray
7999-5203

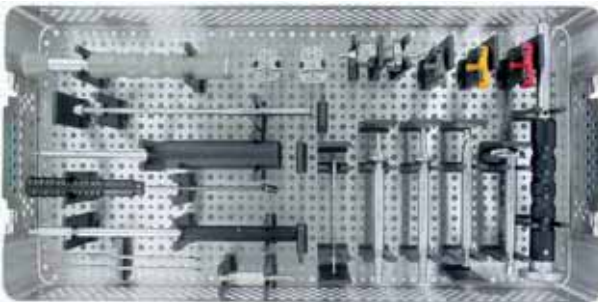

AGILON® glenoid cementless sz. 2-4 container
7999-3837



MUTARS® humerus container 14-16mm
7999-5210

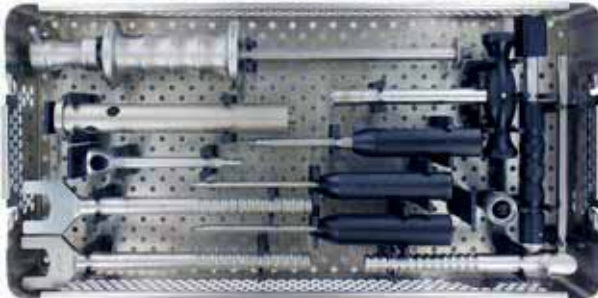

MUTARS® Xpand basic container
7999-5780



MUTARS® Xpand
7999-5781 tibial rasps
7999-5782 femoral rasps

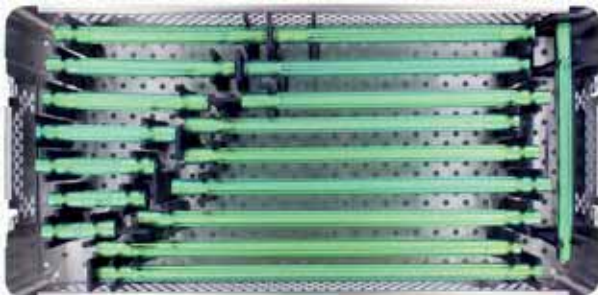

GenuX® MK IMFR trial container
7999-7722

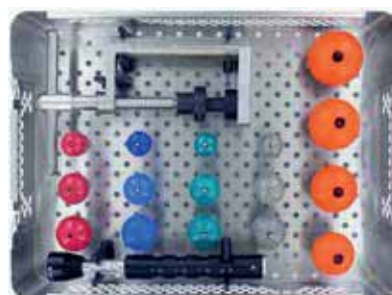

MUTARS® 2M trial RS Cup container
7999-7716

MUTARS® Instruments

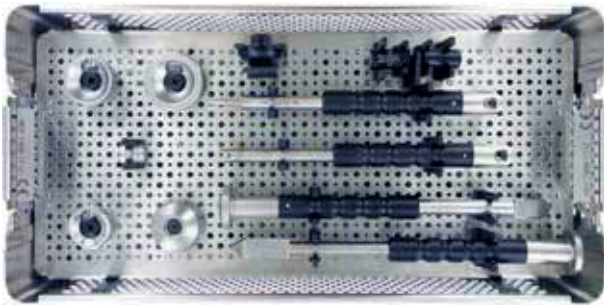

**MUTARS® RS cup container
upper tray**
7999-7712

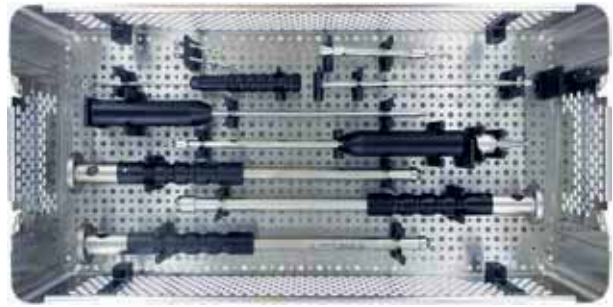

**MUTARS® RS cup container
bottom tray**
7999-7712



**Acetabulum reamer
container**
0282-0001



**MUTARS® RS cup trial cup
container**
7999-7713/14 left/right



**MUTARS® RS Cup PE-trial insert
container**
7999-7715

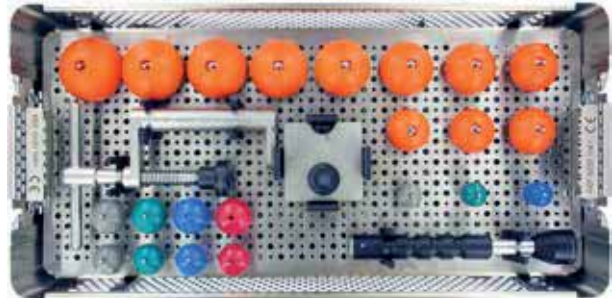

**EcoFit® 2M container I
upper tray**
0220-1081

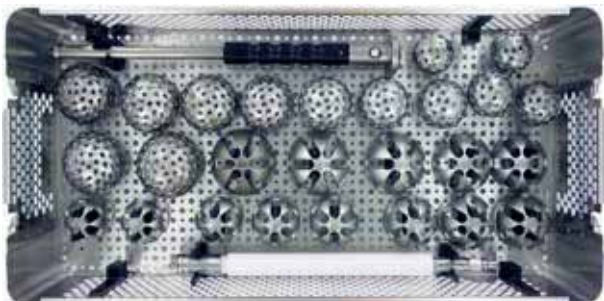

**EcoFit® 2M container I
bottom tray**
0220-1081



**EcoFit® 2M
container 2**
0220-1082



©copyright information: MUTARS®, EPORE®, Aida®, Actinia®, ACS®, AGILON®, AJS®, Bicana® BethaLoc®, Capica®, CarpoFit®, C-Fit 3D®, DiaLoc®, EcoFit®, GenuX®, GIS®, LUMiC®, implavit®, implaFix®, implacross® and implatan® are registered trademarks of implantcast GmbH. The use and copying of the content of this brochure is only allowed with the prior permission of implantcast GmbH. Additional printed trademarks are registered as following:
BioloX® - Ceramtec AG, FITBONE®- WITTENSTEIN intens GmbH, PEEK Optima® - Invibio Inc.



implantcast GmbH
Lüneburger Schanze 26
D-21614 Buxtehude
Germany
phone: +49 4161 744-0
fax: +49 4161 744-200
e-mail: info@implantcast.de
internet: www.implantcast.de



your local distributor:

